

ENFORCER®

EVT-AH16-VT2Q

1U Rack-Mount 16-Channel
Active Balun Hub

Manual



- Transmits up to 5,000ft (1.5km) for color
- 16 Local loop out
- 32 Outputs total
- Rack or wall mountable, stackable
- Fits in standard IT racks
- Adjustable contrast and brightness at each port
- 12~24 VAC/VDC
- Removable terminal blocks
- Built-in video surge protection

SLI® SECO-LARM®



Note: Model numbers that end with "Q" or that have a round green "Q" sticker signify RoHS-compliant products.

Table of Contents:

Introduction.....	2	Wiring	5
Features	2	Connecting to DVR, Video Switcher or Multiplexer	5
Parts List	3	Connecting to Ground.....	6
Specifications.....	3	Adjusting the Image	6
Overview	3	Cable Management	6
Shelf/Table Mounting.....	4	Sample Application	7
Wall Mounting.....	4	Troubleshooting	8
Rack Mounting.....	4		

Introduction:

The ENFORCER EVT-AH16-VT2Q Rack-Mount 16-Channel Active Video Balun Hub allows up to 16 color or monochrome CCTV cameras to be connected via inexpensive CAT5e/6 unshielded twisted pair (UTP) cable to a DVR, video switcher, or multiplexer. It cuts the cost and complexity of security networks by eliminating the need to run expensive coaxial cable to multiple CCTV cameras while transmitting color video signals up to 5,000ft (1.5km).

Features:

- Compact 1U height fits most standard 19" equipment racks.
 - 16 video inputs and 16 video outputs with 16 local loop out.
 - Active operation amplifies the video signal for excellent picture quality at long distances.
 - Transmits color video signal up to 5,000ft (1.5km) using an active balun transmitter and 3,940ft (1.2km) using a passive balun.
 - Uses low-cost Cat5e/6 unshielded twisted pair cable instead of costly coaxial cable.
 - Adjustable contrast and brightness at each port.
 - Built-in video surge protection.
 - Blue LED at each port indicates video signal.
 - Power LED indicates whether the unit is powered.
 - Includes one 1.5A@12VDC adapter.
 - Gold-plated BNC connector.
 - Easy installation: Removable terminal blocks.
 - Perfect for use with DVRs.
-

Parts List:

Rack-mount balun hub	x1
Cable management brackets.....	x2
M3x6 Cable bracket screws	x4
Mounting brackets	x2
Rubber feet.....	x4
Power adapter	x1
Ground wire	x1
Manual	x1

Specifications:

Video input ports	2-wire ports on removable terminal blocks
Video input cables	Unshielded twisted pair (UTP), Cat 2 or better
Video output ports	BNC connectors, each 1Vp-p, 75 ohms
Video output cables	Coaxial
Active to active range	5,000ft (1.5km)
Passive to active range	3,940ft (1.2km)
Video format	NTSC, PAL, SECAM
Power	Dual voltage: 12~24 VAC/VDC (1.5A@12VDC power adapter included)
Surge protection	Video
Operating temperature	32°~131° F (0°~55° C)
Size	1U, 19"x6 ¹¹ / ₁₆ "x1 ³ / ₄ " (482x170x44 mm)
Weight	5-lb (2.2kg)
Material	Steel cabinet, black matte finish

Overview:

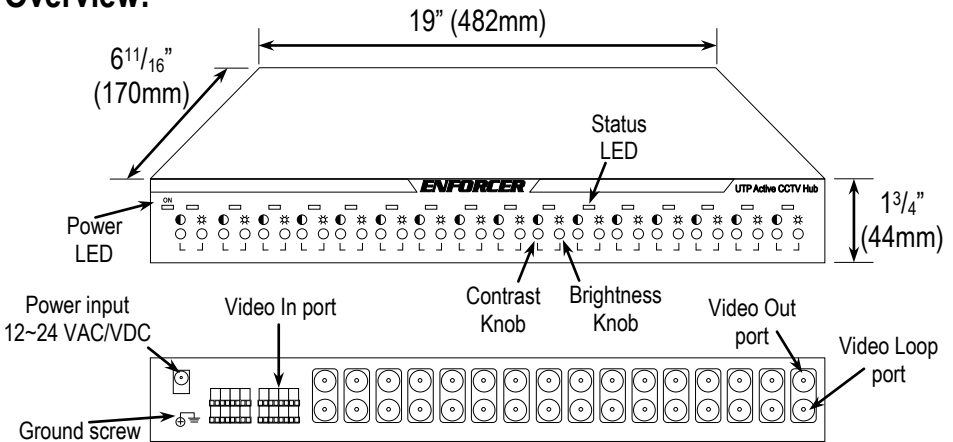

Shelf/Table Mounting:

1. Units may be stacked one on top of the other, or with other equipment.
2. Make sure the rubber feet are firmly attached to the mounting points on the bottom of the unit.

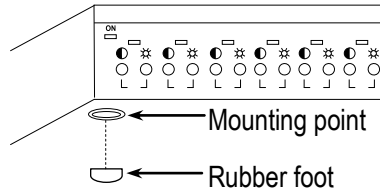

Wall Mounting:

1. Remove the mounting screws from the mounting points.
2. Screw the mounting brackets on, facing downward.
3. Use screws or bolts (not included) to mount the unit in the desired location.
Note: Make sure that the screws/bolts and mounting surface can support the weight of the unit.

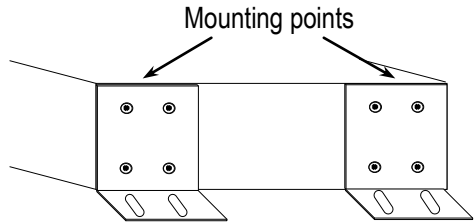

Rack Mounting:

1. Forward facing installation (for easy view of LED indicators)
 - a. Remove the mounting screws from the mounting points at the front of the unit.
 - b. Screw the mounting brackets onto the unit facing forward.
2. Backward facing installation (for easy access to wires)
 - a. Remove the mounting screws from the mounting points at the back of the unit.
 - b. Screw the mounting brackets onto the unit facing the back.
3. Find an appropriate unused 1U space in your equipment rack and screw the unit in place.
4. Leave at least 0.5U **above and below** the unit for ventilation.
Note: No rear support rails are needed. The unit can be fully supported using the mounting brackets provided.

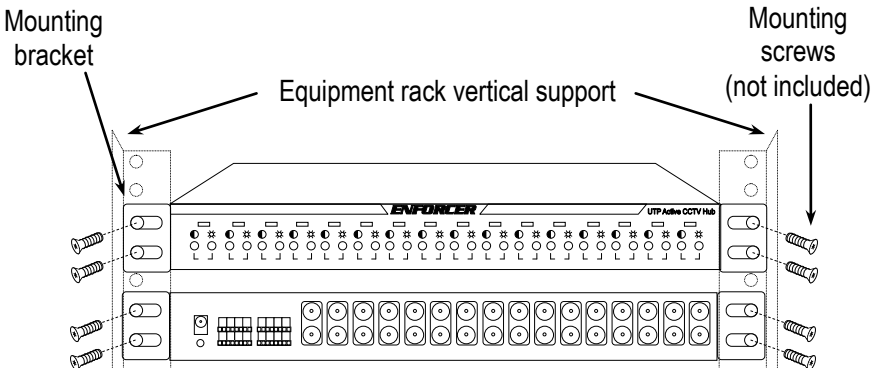

Wiring:

1. Connect the included 12VDC adapter to the EVT-AH16-VT2Q and to a power source.
2. Run a Cat 5e/6 UTP cable from each camera through the wall or through a conduit to the EVT-AH16-VT2Q.

Note: If existing telecom or data UTP cables are available, they can be mixed and matched with new cables. Running two or more cables together should not affect the video signals.

3. Connect a video balun (use active transmitter for best results) to a pair of wires in the UTP cable near the CCTV camera, and then plug the video balun into the camera. Connect the matching pair of wires in the cable at the other end of the correct video-in port on the back of the EVT-AH16-VT2Q.

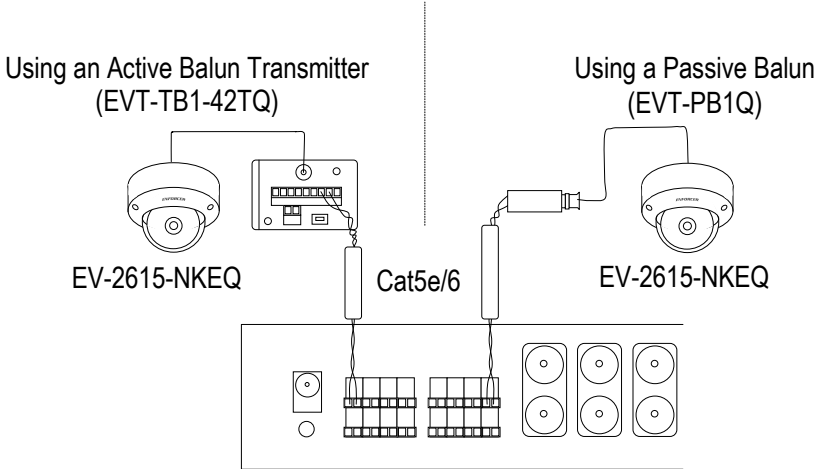

Connecting to DVR, Video Switcher, or Multiplexer:

1. Run one coaxial cable (not included) from the Video Out or Video Loop port on the EVT-AH16-VT2Q and connect it to the corresponding video-in port of the DVR, video switcher, or multiplexer (not included).
2. Repeat the above as necessary until each used channel is connected to the DVR, video switcher, or multiplexer.

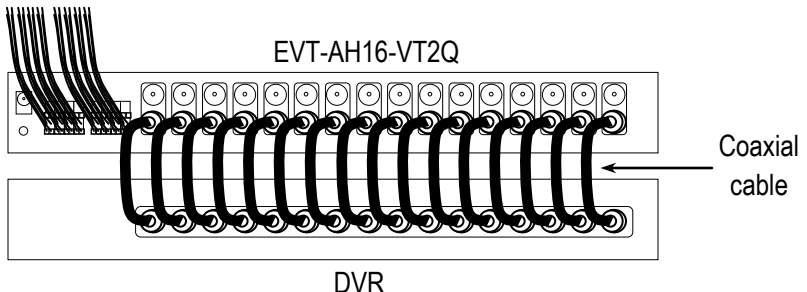

Connecting to Ground:

1. For best surge protection results, connect the included ground wire to the ground screw located on the back of the EVT-AH16-VT2Q.
2. Connect the ground wire to earth ground. (For example, a grounded metal conduit, a cold water pipe, or a grounding rod.)

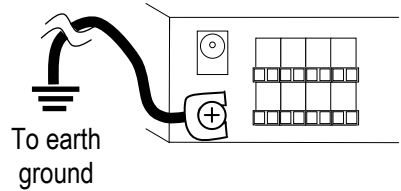

Adjusting the Image:

1. Locate the camera's corresponding output on the front of the EVT-AH16-VT2Q.
2. Adjust the Contrast and Brightness adjustment knobs by hand.

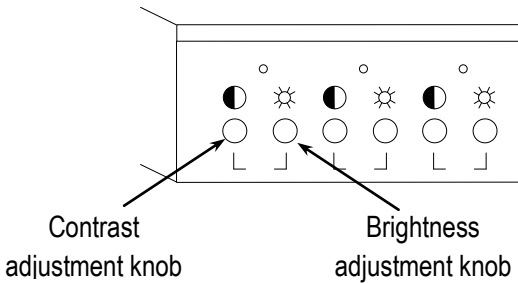

Cable Management:

1. Screw the two included "G" brackets onto the mounting point on the rear of the unit with the included M3x6 screws. Mount the brackets open end at the top.
2. Mount the brackets and route power cables in a way that best suits your installation. Be sure to leave slack in the cable to ease future maintenance. Use cable ties (not included) to reduce cable tension.

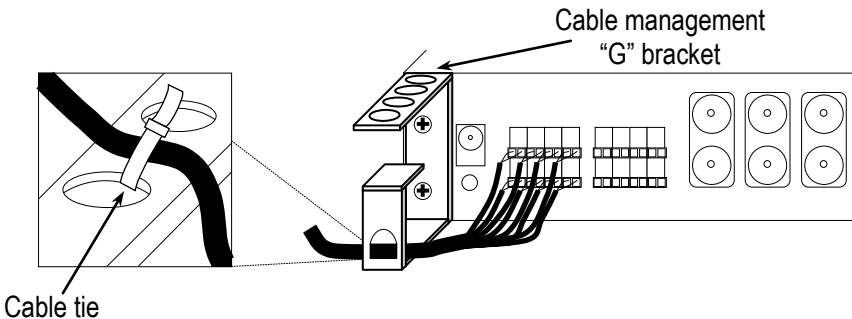

Sample Application:

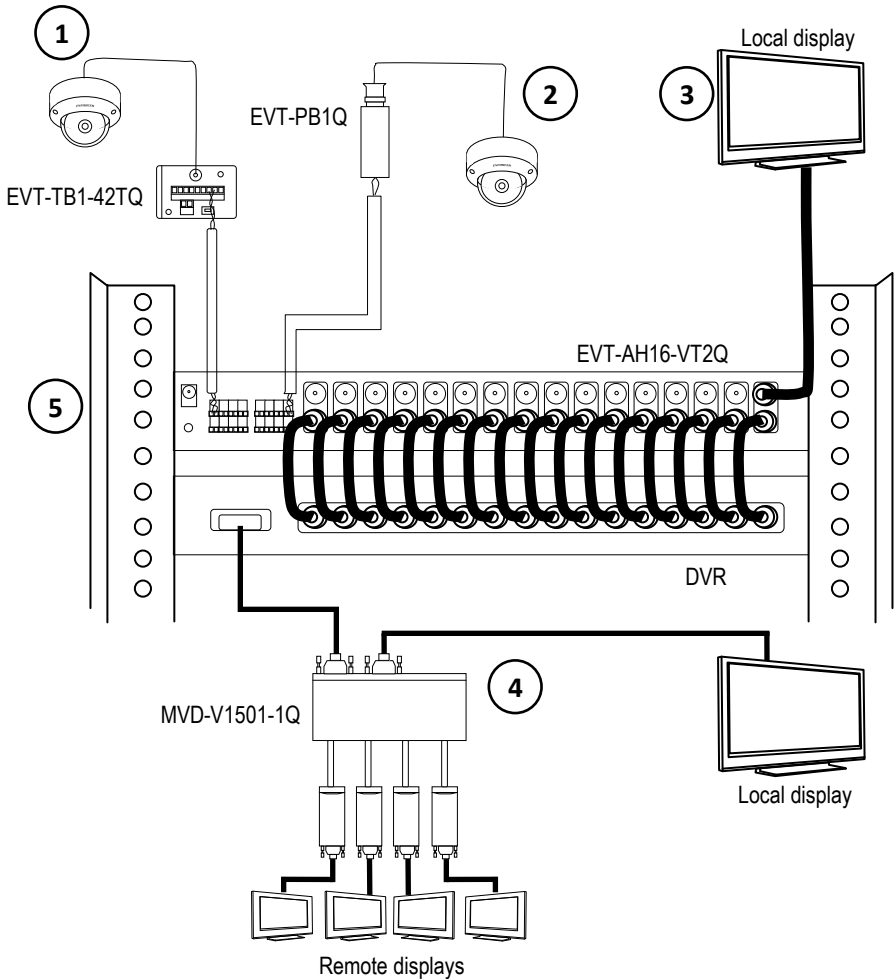

1. The EV-2615-NKEQ NVD Dome Camera is connected to the EVT-AH16-VT2Q through the EVT-TB1-42TQ Active Balun Transmitter.
2. The EV-2615-NKEQ NVD Dome Camera is connected to the EVT-AH16-VT2Q through the EVT-PB1Q Passive Video Balun.
3. A security monitor is connected directly to the EVT-AH16-VT2Q's video output.
4. The EVT-AH16-VT2Q is connected to a DVR. The MVD-V1501-1Q VGA Extender over Cat5e/6 connects to the DVR's VGA output, allowing the connection of up to 5 more displays.
5. The EVT-AH16-VT2Q unit is mounted to a standard IT rack using rear mounting.

Troubleshooting:

The screen is blank	<ul style="list-style-type: none">• Check that the Active Video Balun Hub is plugged in.• Check that the CCTV camera is powered up.• Check that the video cable connecting the camera to the hub is connected properly.• Check that the cable(s) connecting the hub to the monitor, switcher, DVR, or multiplexer are connected properly.• Double-check the connections to any passive or active baluns.
The screen image is dim	<ul style="list-style-type: none">• Clean the camera lens (using a soft, clean cloth).• Check that the camera light source is adequate.• Clean the camera dome (if applicable).• If the backlight control (BLC) DIP switch on the camera is set to OFF, try setting it to ON.
The screen image is dark	<ul style="list-style-type: none">• Adjust the Brightness on the Active Balun Hub.• Check that the automatic electronic shutter (AES) DIP switch on the camera is turned OFF.
The screen image has poor contrast	<ul style="list-style-type: none">• Adjust the monitor's contrast knob.• Adjust the Contrast on the Active Balun Hub.• Change the position of the camera.
The screen image flickers	<ul style="list-style-type: none">• Change the position of the camera.
The screen image rolls	<ul style="list-style-type: none">• If multiple cameras are used, make sure the polarity of the power connections is consistent.
The screen image is distorted	<ul style="list-style-type: none">• (24VAC only) If more than one camera is attached to the same power source, adjust the other camera's linelock sync.• Change the position of the camera.
The camera case is hot	<ul style="list-style-type: none">• Check that the correct power supply is in use.

IMPORTANT: Users and installers of this product are responsible for ensuring this product complies with all national, state, and local laws and statutes related to monitoring and recording audio and video signals. SECO-LARM will not be held responsible for the use of this product in violation of any current laws or statutes.

WARNING: Incorrect mounting which leads to exposure to rain or moisture inside the enclosure could cause a dangerous electric shock, damage the device, and void the warranty. Do not open the case of this device, as there are no field-serviceable components inside.

WARRANTY: This SECO-LARM product is warranted against defects in material and workmanship while used in normal service for a period of one (1) year from the date of sale to the original consumer customer. Our obligation is limited to the repair or replacement of any defective part if the unit is returned, transportation prepaid, to SECO-LARM. For complete details regarding the SECO-LARM warranty, please contact SECO-LARM.

NOTICE: The information and specifications printed in this manual are current at the time of publication. However, the SECO-LARM policy is one of continual development and improvement. For this reason, SECO-LARM reserves the right to change specifications without notice. SECO-LARM is also not responsible for misprints or typographical errors.

Copyright © 2010 SECO-LARM U.S.A., Inc. All rights reserved. This material may not be reproduced or copied, in whole or in part, without the written permission of SECO-LARM.

SECO-LARM® U.S.A., Inc.

16842 Millikan Avenue, Irvine, CA 92606

Tel: 800-662-0800/ 949-261-2999 Fax: 949-261-7326

Website: www.seco-larm.com

E-mail: sales@seco-larm.com

PITSW4
MI/EVT-AH16-VT2Q_1003.docx