

SECO-LARM

Double-Door Electromagnetic Lock

E-941DA-600Q 600-lb. (272kg)

E-941DA-1K2Q 1200-lb. (545kg)

With LED, Bond Sensor

E-941DA-600PQ 600-lb. (272kg)

E-941DA-1K2P 1200-lb. (545kg)



MANUAL



SECO-LARM SLI



NOTE: Products with model numbers ending in "Q" or labeled with a round green "Q" sticker are certified RoHS compliant.

SECO-LARM ELECTROMAGNETIC LOCK

Table of Contents:

Introduction	2	Installation Notes	4
Features	2	Installation	4-6
Parts List	2	Wiring Diagram	7
Specifications	2	Maximum Wiring Distance	7
Overview.....	3	Troubleshooting	8
Installation Applications	3	Warranty.....	8

Introduction:

The E-941DA series of electromagnetic locks is the ideal way to secure double doors against unauthorized entry. When power is applied to the electromagnetic locks, it creates an extremely strong magnetic field. The electromagnets are strongly attracted to the steel armature plates which are mounted on the protected doors. Once the electromagnets are deactivated, the secured doors will open and close normally without any residual magnetism.

Features:

- Anodized aluminum.
- No residual magnetism.
- MOV surge protection.
- Adjustable mounting bracket.
- Complete mounting hardware for typical installations.
- "L" bracket and "Z" brackets available for easy mounting.
- 12/24VDC selectable.
- Detachable faceplate.

E-941DA-1K2P and **E-941DA-600PQ** also feature:

- 2 Built-in dual-colored status LED and bond sensors to show locking status of each door:

Green	Door is closed and locked
Red	Door not closed and/or locked
Off	Door in use / No power

Parts List:

- 1 x Mounting plate
- 1 x Electromagnet
- 2 x Armature plate
- 2 x Armature screw
- 4 x Steel washers
- 2 x Rubber washer
- 2 x Door spacer
- 2 x Sexnut bolt
- 4 x Guide pins
- 8 x Long self-tapping screws
- 4 x Short self-tapping screws
- 4 x Hex-head mounting screws
- 4 x Tamper caps
- 1 x Allen wrench

Specifications:

Operating voltage		12 or 24 VDC ±10%	
Current draw	12VDC	500mA@12VDC per door (1A total)	
	24VDC	250mA@24VDC per door (500mA total)	
Coil resistance		48Ω ±10% per coil (see page 8)	
Bond sensor relay		3A@12VDC	
Dimensions	Magnet	600-lb.	19 ^{11/16} " x 11 ^{1/16} " x 1 ^{5/8} " (500 x 26 x 40 mm)
		1,200-lb.	21" x 15 ^{5/8} " x 2 ^{5/8} " (536 x 42 x 67 mm)
	Armature plate	600-lb.	7 ^{1/4} " x 1 ^{1/2} " x 1 ^{1/2} " (185 x 12 x 38 mm)
		1,200-lb.	7 ^{1/4} " x 5 ^{5/8} " x 2 ^{3/8} " (185 x 16 x 61 mm)
Operating temperature		14°~131° F (-10°~55° C)	
Weight	600-lb.	9lbs. (4kg)	
	1,200-lb.	21lbs. (10kg)	

Overview:

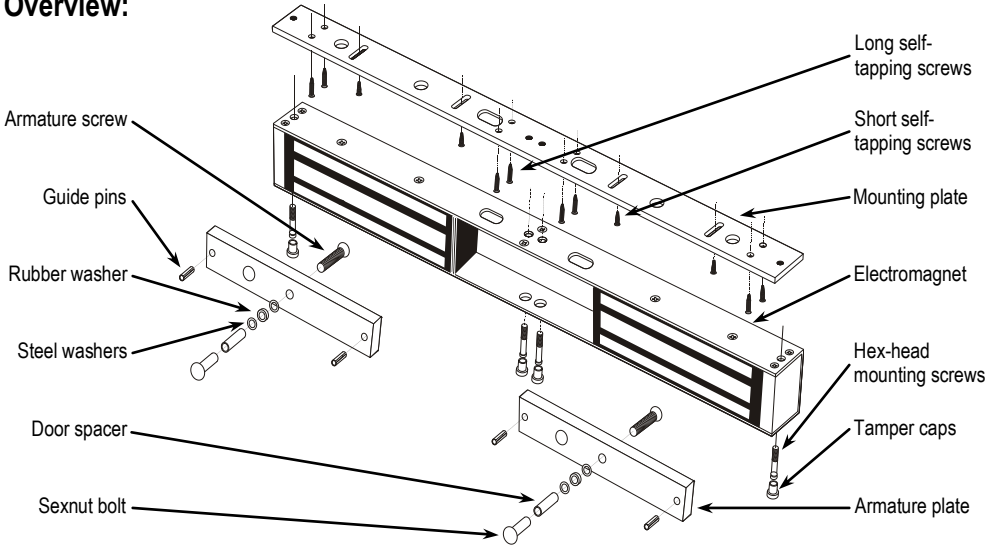

Installation Applications:

NOTE: When mounting the electromagnets, it may be necessary to use a "Z"-bracket, 1 or 2 "L"-brackets, and/or plate spacers, depending on the location and the type of doors and frame. Use the diagram below to help decide whether or not an optional bracket will be necessary for installation.

See page 7 for a complete list of SECO-LARM accessories.

Typical Installation

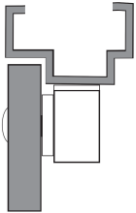
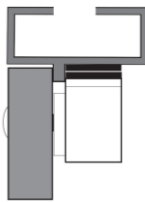
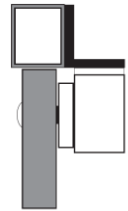

Plate Spacers



"L" Bracket



"L"-Bracket and "Z"-Bracket

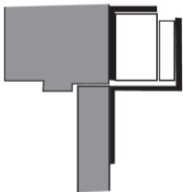

"U" Bracket
(Typically for glass doors)

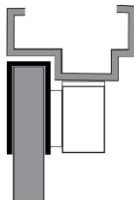

Armature-Mounting Plate

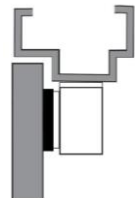

SECO-LARM ELECTROMAGNETIC LOCK

Installation Notes:

1. Read this installation manual thoroughly. A clear understanding of the product and this manual will make installation much easier.
2. The electromagnetic locks are designed for indoor use ONLY.
3. The most suitable mounting location for the electromagnetic locks may require the use of additional SECO-LARM accessories such as Z-brackets, L-brackets, and/or spacer plates. Please see the diagram on page 3 to decide if a particular application requires any mounting accessories. See page 7 for a complete list of SECO-LARM accessories.
4. Do not run power wires and signal wires in the same conduit as this may cause interference.
5. Do not install a diode in parallel with the electromagnetic locks as this may cause a delay when releasing the door as well as cause residual magnetism.
6. The best location to install the electromagnetic locks is on the inside of the doors that are being secured with the wiring concealed in the frame to prevent tampering with the unit.

Installation:

1. Fold the mounting template along the dotted line to form a 90-degree angle.

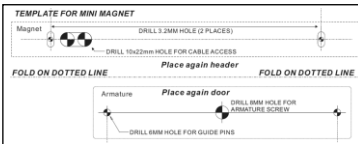
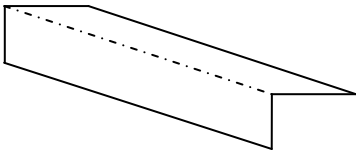

2. Close the doors. Find a mounting location on the center of the door frame, directly above where both doors meet when closed.

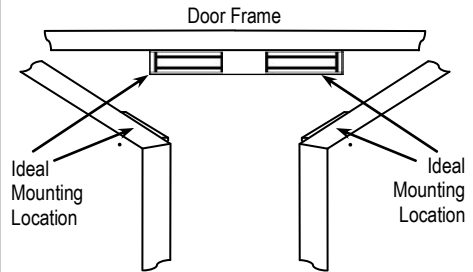

3. Place the template against the door and frame. Mark where the holes are to be drilled.

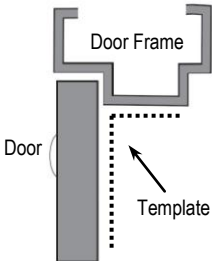

4. Drill four holes in the frame and six holes in the door as shown on the template.

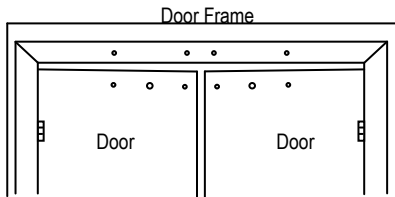

5. Use a hammer to lightly tap the guide pins into the guide pin holes on the armature plates.
6. .

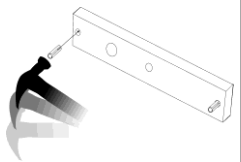

6. Depending on the type of door being protected, drill holes according to the diagrams below:

Hollow Metal Door

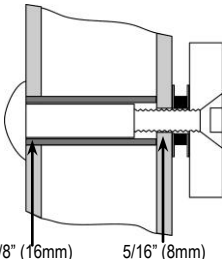

Reinforced Door

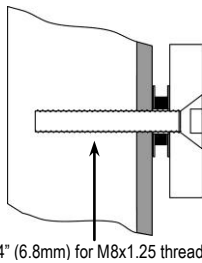

Solid Core Door

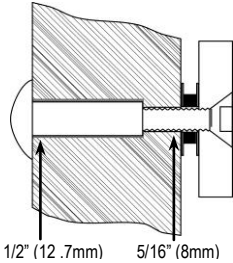

Drill two 5/16" (8mm) dia. holes through the armature-plate side of the doors for the armature screws. Then drill two 5/8" (16mm) dia. holes for sexnut screws on the opposite side of the doors.

Drill two 1/4" (6.8mm) dia. and 1" (25mm) deep hole, tap for M8x1.25 thread on each door.

Drill two 5/16" (8mm) dia. holes on the doors for the armature screws, and drill two 1/2" (12.7mm) dia. and 1" (25mm) deep hole for the sexnut screws.

7. Put a rubber washer between the two metal washers, and place them over the armature screw between the armature plates and the doors. This allows the plates to pivot around the screw to compensate for door misalignment.

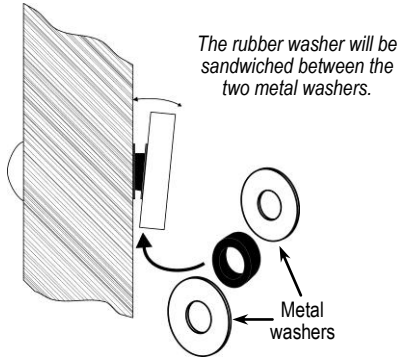

8. Tighten the armature screws enough so that the armature plates can withstand a break-in attempt, but loose enough so that the armature plates can pivot slightly. Make sure the anti-spin guide pins are in the two guide pin holes.

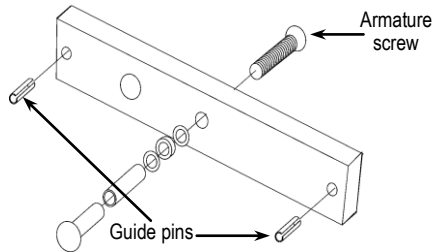

Tip: Use a thread-locking compound on the armature screws to ensure a long-lasting installation.

9. Screw the four short self-tapping screws through the mounting plate's slotted holes, but do not over-tighten them. Keeping them loose will allow for adjustment of the plate left or right so that the mounting plate and the armature plates form a 90-degree angle. See the diagram below.

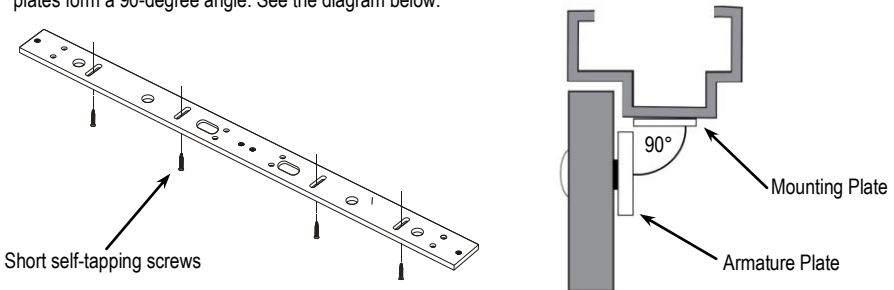

SECO-LARM ELECTROMAGNETIC LOCK

- 10.** Once the position of the mounting plate is correct, use the eight long self-tapping screws to permanently mount the mounting plate.

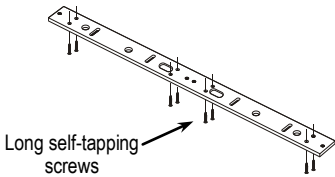

- 11.** Drill the cable access holes. Run the power leads through the cable access holes in the mounting plate and through the holes in the door frame.

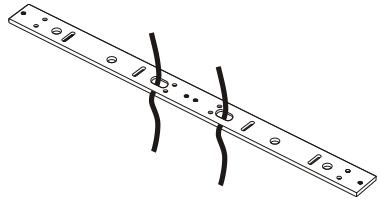

- 12.** Remove the cover from the front of the electromagnets. Run the power leads through the large cable access holes.

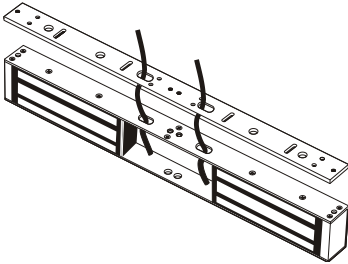

- 13.** Push the electromagnet against the mounting plate so the ends are flush with the each other. Use the Allen wrench to screw the hex-head mounting screws through the bottom of the electromagnets into the mounting plate.

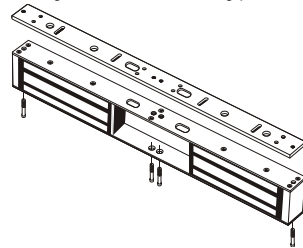

- 14.** Cut the wires so they are long enough to connect with the terminal block. Set the voltage using the selection jumpers based on your input voltage.

CAUTION: The two electromagnets each have their own voltage selection jumpers.

Voltage Selection Jumpers



Position two jumpers on all four pins for 12VDC operation



Position a jumper over the two middle pins for 24VDC operation

NOTE: Failure to correctly set the input voltage may cause damage to the lock.

- 15.** Connect the power wires according to the wiring diagram on page 7. Test the unit. Then replace the front cover and install the hex-head tamper caps.

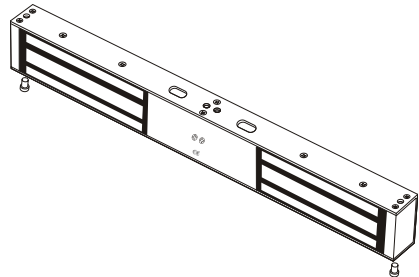

NOTE: This should be the very last step, as once the tamper caps are in place they are very difficult to remove.

Also Available from SECO-LARM:

Access Control
Power Supply



EAP-5D1Q

Stand-Alone
Access Keypads



SK-1123-SQ
(shown)

Complete line of
Electromagnetic
Locks and Strikes



E-941SA-1200
(shown)



Voltage
Converters or
Booster



ST-LA110-TTQ
(shown)

Wired or Wireless
RTE Plates



SD-7202GC-PEQ
(shown)

Wiring Diagram:

CAUTION: Each lock has its own circuit board, for a total of two circuit boards. Please wire each circuit board and program the voltage-jumper selections according to the diagram below.

Bond Status Sensor:

The Bond Status Sensor checks to make sure the door is closed, and the electromagnet is locked.

LED Indicators:

Green	Door is closed and locked
Red	Door not closed and/or locked
Off	Door in use / No power

600PQ and 1K2P models ONLY

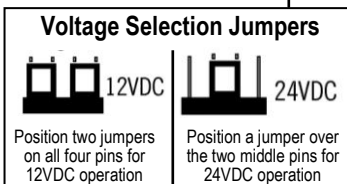
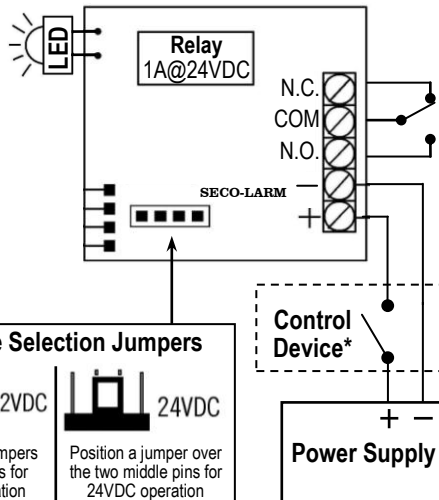

***NOTE:** Connect switching devices like push-to-exit switches between the power source and the positive terminal on the lock. Connecting switching devices to the negative terminal may cause a delay in unlocking.

Maximum Distance from Power Source to Electromagnetic Lock:

For a complete chart, please visit www.seco-larm.com





12VDC Minimum Wire Gauge:

Wire Length	25ft.	50ft.	75ft.	100ft.	150ft.	200ft.	250ft.	300ft.	400ft.	500ft.	1000ft.
Wire Gauge @ 500mA	20	18	18	18	16	14	14	12	10	--	--

24VDC Minimum Wire Gauge:

Wire Length	25ft.	50ft.	75ft.	100ft.	150ft.	200ft.	250ft.	300ft.	400ft.	500ft.	1000ft.
Wire Gauge @ 250mA	24	24	22	20	18	18	16	16	14	14	14

Optional SECO-LARM Electromagnetic Lock Accessories:

					
Description	"Z" Brackets (includes 1 "L" Bracket)	"L" Brackets	Plate Spacers	Glass Door "U" Brackets	Armature Plate Holders
600-lb. Models	E-941S-600/ZQ	E-941S-600/LQ	E-941S-600/PQ	E-941S-600/UQ	E-941S-600/HQ
1200-lb. Models	E-941S-1K2/ZQ	E-941S-1K2/LQ	E-941S-1K2/PQ	E-941S-1K2/UQ	E-941S-1K2/HQ
Additional Models	E-941S-1K2/ZRQ (Right-side "Z" Bracket for E-941DA-1K2P)		E-941D-1K2/P (for E-941DA-1K2P)		

SECO-LARM ELECTROMAGNETIC LOCK

Troubleshooting:

Doors do not lock Bond status LEDs do not illuminate	<ul style="list-style-type: none">• Check to make sure the wires are securely tightened to the terminal block.• Check that the power supply is connected and operating.• Use a meter to check the resistance of coils inside the locks. See below.• Make sure the rubber washer is installed and free from damage.
Doors lock, but can easily be forced open	<ul style="list-style-type: none">• Make sure the electromagnet and armature plates are properly aligned.• Make sure the contact surfaces of the electromagnet and armature plates are clean and free from rust.• Check the power leads with a meter, and make sure 12VDC or 24VDC is present.• Use a meter to check the resistance of coils inside the locks. See below.• Make sure the rubber washer is installed and free from damage.
Delay in door releasing	<ul style="list-style-type: none">• The electromagnet is fitted with a metal oxide varistor to prevent interference, so do not install a second diode.
No relay output	<ul style="list-style-type: none">• Check that the power is connected properly and turned on.• Make sure the locks are aligned properly.• Make sure the NO/NC/COM are wired properly.

If the Electromagnet has low or no holding force, check the resistance of the coils by performing the following steps:

1. Remove the faceplate from the lock.
2. Disconnect the wire harness from the circuit board.
3. Using a meter, measure the resistance across:
Red / Green wires, and the Black / White wires.
4. Each coil should test at $48\Omega \pm 10\%$.
5. If one or both of coils shows an open, short, or incorrect resistance, replace the electromagnet.

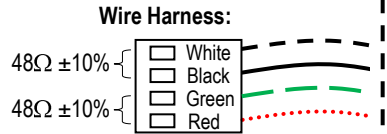

LIFETIME LIMITED WARRANTY This SECO-LARM product is warranted against defects in material and workmanship while used in normal service for the lifetime of the product. SECO-LARM's obligation is limited to the repair or replacement of any defective part if the unit is returned, transportation prepaid, to SECO-LARM. Under no circumstances will SECO-LARM be responsible for any costs or charges for removal, installation, or reinstallation. This Warranty is void if damage is caused by or attributed to acts of God, physical or electrical misuse or abuse, neglect, repair, or alteration, improper or abnormal usage, or faulty installation, or if for any other reason SECO-LARM determines that such equipment is not operating properly as a result of causes other than defects in material and workmanship. The sole obligation of SECO-LARM, and the purchaser's exclusive remedy, shall be limited to repair or replacement only, at SECO-LARM's option. In no event shall SECO-LARM be liable for any special, collateral, incidental, or consequential personal or property damages of any kind to the purchaser or anyone else. This lifetime limited warranty is for products sold and installed in the United States and Canada. For all other countries the warranty is 1 (one) year.

NOTICE: The information and specifications printed in this manual are current at the time of publication. However, the SECO-LARM policy is one of continual development and improvement. For this reason, SECO-LARM reserves the right to change specifications without notice. SECO-LARM is also not responsible for misprints or typographical errors. Copyright © 2010 SECO-LARM U.S.A., Inc. All rights reserved. This material may not be reproduced or copied, in whole or in part, without the written permission of SECO-LARM.

SECO-LARM U.S.A., Inc.

16842 Millikan Avenue, Irvine, CA 92606

Tel: 800-662-0800 / 949-261-2999 Fax: 949-261-7326

Website: www.seco-larm.com

E-mail: sales@seco-larm.com

 PITGW1

ME941DA_1007.docx