

# ENFORCER®

## Outdoor No Touch Request-To-Exit Sensor

### Manual



	Slimline Plate	Single Gang Plate	European Plate
<b>Language</b>			
English	SD-9163-KSQ	SD-9263-KSQ	SD-9363-KSQ
Spanish	SD-9163-KS1Q	SD-9263-KS1Q	n/a
French	SD-9163-KS2Q	SD-9263-KS2Q	n/a
English w/ mechanical override button	SD-9163-KSVQ	SD-9263-KSVQ	n/a

**Featuring:**

- Built-in Timer (0.5~30 seconds or toggle)
- Programmable LED (Red to Green or Green to Red)

The ENFORCER Outdoor No Touch Request-To-Exit Sensor is a full-featured exit plate which uses IR technology to allow egress from a protected area or activate a device with the simple wave of a hand. Since it is No Touch, this sensor is ideal for use in hospitals, clinics, labs, cleanrooms (to reduce the risk of contamination), schools, factories, or offices.

# ENFORCER® No Touch Request-To-Exit Sensor

## Features:

- Adjustable sensor range up to 7" (18cm).
- Weather resistant for outdoor use.
- Stainless steel plate.
- 1A relay, adjustable trigger duration 0.5~30 seconds or toggle.
- LED illuminated sensor area for easy identification.
- Selectable LED colors (turns from red to green or green to red) to show sensor activated.

## Overview:

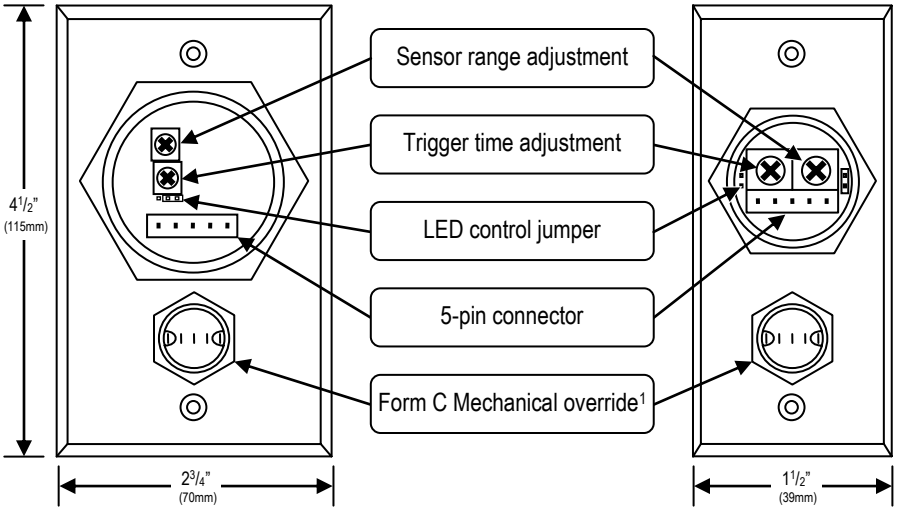

¹SD-9163-KSVQ and SD-9263-KSVQ

## Specifications:

Power		12~24 VDC
Current drain (max.)	Standby	16mA@12VDC / 25mA@24VDC
	Triggered	25mA@12VDC / 32mA@24VDC
Relay type		Form C dry contact, 1A@30VDC
Response time		10ms
LEDs	Standby	Red <sup>2</sup>
	Triggered	Green <sup>2</sup>
Output time		0.5~30 s, toggle
Range		2"~7" (5~18 cm)
IP rating		IP65 <sup>3</sup>
Temperature range		-4°~131° F (-20°~55° C)
Weight	Single Gang	108g
	Single Gang w/ Mechanical Override	125g
	Slimline	61g
	Slimline w/ Mechanical Override	77g
	European Plate	77g

<sup>2</sup>Color function reversible

<sup>3</sup>Front panel only.

SD-9263-KSVQ shown

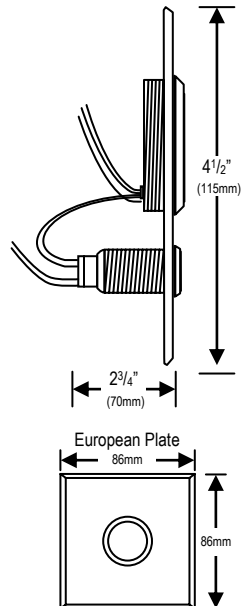

## Wiring Diagram:

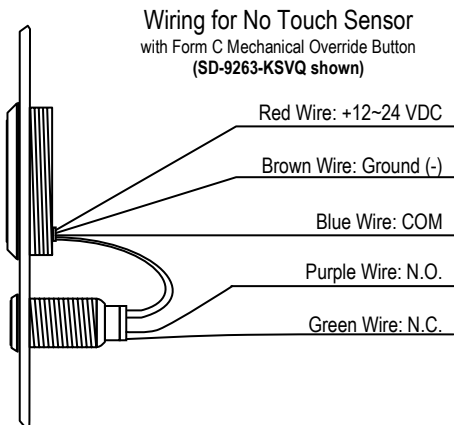
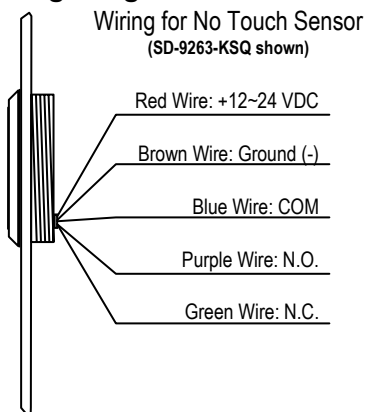

## Installation:

1. Run four wires through the wall to a single-gang or slimline back-box.
2. Connect the four wires from the back-box to the Request-to-Exit Sensor according to the **Wiring Diagram** above.
3. Screw the plate into the back-box, taking care not to crimp the wires.
4. Remove clear protective film from the sensor before use.

**WARNING:** Do not connect any device that will exceed 1A@30VDC.

## Changing the LED Color Jumper Placement:

Slimline Models

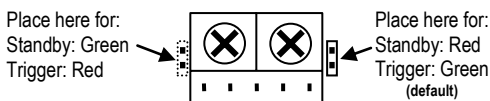

Single-Gang Models

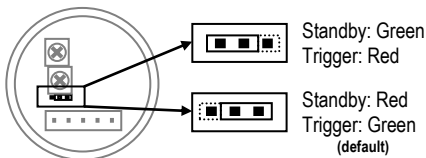

## Adjusting the sensor range and trigger time:

1. The sensor range can be adjusted from 2"~7" (5~18 cm).
2. The trigger time can be adjusted from 0.5 to 30 seconds or toggle<sup>4</sup>.

**NOTE:** Do not force the adjustment trimpots to turn. Only minimal force is needed.

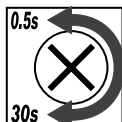

Trigger time: 0.5~30 seconds, toggle<sup>4</sup>  
Default: 0.5 seconds  
<sup>4</sup>Toggle: turn all the way clockwise

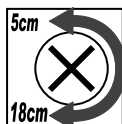

Sensor range: 2"~7" (5~18 cm)  
Default: 7" (18cm)

<sup>4</sup>Set trigger time to maximum

Single gang models

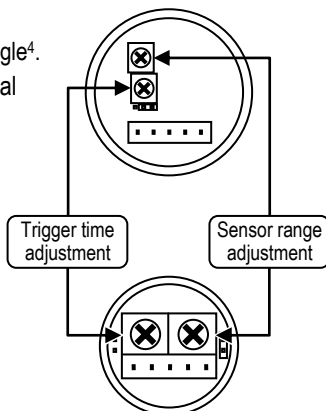

Slimline models

## Example Installation:

Typical installation with an electric lock:

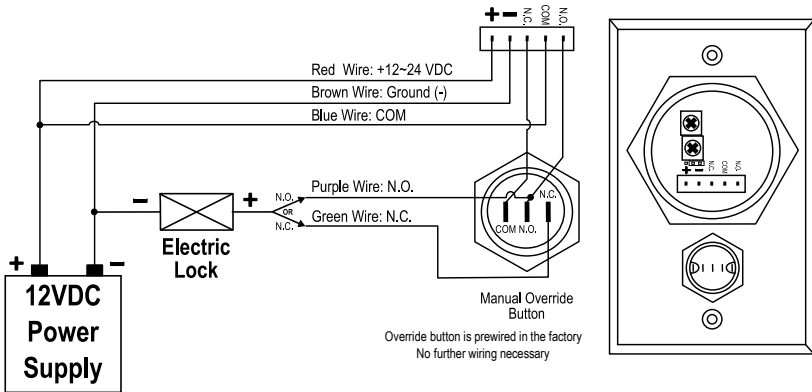

## Care and Cleaning for the SD-9x63 Series Sensor:

The sensor requires special care to ensure reliability and a long operating life.

1. Use a soft, clean cloth for cleaning. Use the mildest type of cleaner available.
2. When cleaning, spray the cleaning solution onto the cleaning cloth instead of the unit.
3. Be sure to wipe off any excess liquid from the sensor. Wet spots or areas may affect the sensor's performance.

**WARNING:** Incorrect mounting which leads to exposure to rain or moisture inside the enclosure could cause a dangerous electric shock, damage the device, and void the warranty.

**WARRANTY** This SECO-LARM product is warranted against defects in material and workmanship while used in normal service for a period of one (1) year from the date of sale to the original consumer customer.

SECO-LARM's obligation is limited to the repair or replacement of any defective part if the unit is returned, transportation prepaid, to SECO-LARM.

This Warranty is void if damage is caused by or attributed to acts of God, physical or electrical misuse or abuse, neglect, repair, or alteration, improper or abnormal usage, or faulty installation, or if for any other reason SECO-LARM determines that such equipment is not operating properly as a result of causes other than defects in material and workmanship.

The sole obligation of SECO-LARM, and the purchaser's exclusive remedy, shall be limited to replacement or repair only, at SECO-LARM's option. In no event shall SECO-LARM be liable for any special, collateral, incidental, or consequential personal or property damages of any kind to the purchaser or anyone else.

**NOTICE:** The information and specifications printed in this manual are current at the time of publication. However, the SECO-LARM policy is one of continual development and improvement. For this reason, SECO-LARM reserves the right to change specifications without notice.

SECO-LARM is not responsible for misprints or typographical errors.

Copyright © 2014 SECO-LARM U.S.A., Inc. All rights reserved. This material may not be reproduced or copied, in whole or in part, without the written permission of SECO-LARM.

## **SECO-LARM**® U.S.A., Inc.

16842 Millikan Avenue, Irvine, CA 92606  
Tél: 800-662-0800 / 949-261-2999 Fax: 949-261-7326

Website: [www.seco-larm.com](http://www.seco-larm.com)  
Email: [sales@seco-larm.com](mailto:sales@seco-larm.com)

 PITSW1  
M:SD-9x63-KSxQ\_1405.docx  
Order Part # 763-171-5%