

# Installation Manual

## **ENFORCER**<sup>®</sup>

### **SK-910R4Q** **SK-910R4-4Q** **Four-Channel RF Receivers**



- Operates on 11-24VAC/VDC\*
- Up to 500 ft. range

**Models Available** ( See SECO-LARM for details )

<b>SK-910RQ</b> .....	One-channel receiver, 315MHz
<b>SK-910RLQ</b> .....	Low-voltage, one-channel receiver, 315MHz
<b>SK-910RVQ</b> .....	Low-voltage, one-channel receiver, Transistor ground output, 315MHz
<b>SK-910R2Q</b> .....	Two-channel receiver, 315MHz
<b>SK-910R-4Q</b> .....	One-channel receiver, 433.92MHz
<b>SK-910RL-4Q</b> .....	Low-voltage, one-channel receiver, 433.92MHz
<b>SK-910R2-4Q</b> .....	Two-channel receiver, 433.92MHz
<b>SK-910RV-4Q</b> .....	Low-voltage, one-channel receiver, Transistor ground output, 433.92MHz

---

## **Introduction**

The SK-910R4Q is a four-channel receiver which meets the growing demand for a multi-channel receiver with multiple and independently controlled output modes. This RF receiver is compatible with both code hopping and fixed-code transmitters (see page 4 of this manual for a list of compatible transmitters). The receiver can be used to control a variety of home automation devices, such as garage door openers, lights, motorized gates, lifts, or other devices.

## **Installation Notes**

1. Mount out of sight in a location where it is not surrounded by metal, and where it is not exposed to the weather or to moisture. Metal will block the RF signal, resulting in a reduced range.
2. For best range, pull the antenna wire as long and straight as possible. If the receiver receives interference from local RF activity (e.g., an airport or military base), the antenna wire can be folded. **DO NOT CUT THE ANTENNA WIRE.**

\* All models work on 11-24VAC/VDC, except for the low voltage versions.

\*\* This manual covers only four-channel receivers. For information on our one- and two-channel receivers, please contact SECO-LARM.

Note: Model numbers that end with "Q" indicate RoHS compliant products.

## Code Learning a New Transmitter Button

Each receiver channel can learn the codes of up to 15 different transmitter buttons on a first-in, first-out basis. Below is the procedure for code learning a new transmitter button. The same procedure applies to all the receiver's four channels.

1. Press the mode switch of the desired channel to be programmed for 3 seconds or more. The channel's red LED will start to flash quickly to indicate that it is in the learning mode.
2. While the red LED is quickly flashing, press the button of the transmitter to be learned once. The red LED will flash once to indicate a successful learning of that button's code.

NOTE: a) The mode switches can be found at the rear of the receiver's case (see Fig. 1). The switch marked #1 represents the mode switch for channel 1, switch #2 is the mode switch for channel 2, and so on.

- b) The channel's red LED will flash a maximum of 15 seconds. If no transmitter button is pressed during this time, the receiver will exit the code-learning mode, and the red LED will turn off.
- c) If the code being learned has already been learned, the red LED for the channel which learned the code will turn steady ON, and the code will not be learned a second time.
- d) Each channel can learn the codes of a maximum of 15 transmitter buttons. If you attempt to learn a sixteenth button, the earliest code learned will be deleted.

## Channel Memory Clear

To clear all codes in the channel's memory, enter the channel learning mode first, then press the channel mode switch for 3 or more seconds again. The LED flashes twice to indicate that all codes associated with that channel are now deleted.

## Channel Memory Display

To see how many codes have been learned in a channel, press that channel's mode switch once. The number of codes stored in the channel's memory is equal to the number of LED flashes.

## Programming Each Channel Relay Output Mode

Each receiver's channel can be programmed for one of four different modes, and each individual channel may operate at a different output mode, depending on the user's application. Applications are as follows:

- **Timed Output** — Press the transmitter button once. The timed output relay will activate from 1 ~60 seconds, depending on how long the timed output duration is set (Factory default is 1-second timed output.).
- **Toggle Output**— Works much like a toggle switch to turn a device ON & OFF alternately. Press the transmitter button once, and the relay turns on. Press a compatible transmitter button again, and the relay turns off.
- **Latch Output**— Press the transmitter button once, and the relay turns on and stays on. The relay will remain on until the appropriate channel mode switch is pressed once to reset, regardless of whether a compatible transmitter button is pressed again or not.
- **Validity Output**— The channel will turn the relay ON for as long as the transmitter button is pressed.  
Note: Care must be taken when using validity output. Due to possible interference or drops in transmitter battery power while the transmitter button is continuously pressed (even for short periods of time), the receiver may lose the transmitter's signal and turn the relay off.

To program each channel output mode, press the programming mode switch once (switch #5, see Fig. 1). Each channel's red LED will flash a number of times equal to the output mode that it is in. Below are the channel output LED flash indicators:

- |                               |                                  |
|-------------------------------|----------------------------------|
| 1.) One flash —Timed Output   | 3.) Three flashes—Latch Output   |
| 2.) Two flashes—Toggle Output | 4.) Four flashes—Validity Output |

Press the mode switch of the desired channel to be programmed a number of times until the required output is achieved. The programming procedure for all four channels is the same. To exit programming, press programming mode switch again.

## Setting the Timed Output Timer

When a relay output is set to "timed output," it turns ON for 1 to 60 seconds when a compatible transmitter button is pressed. To program the output timer, flip the DIP switches in the timer programming switch according to Table 1.

Note: The SK-910R4Q has only one timer. If more than one relay is set to "timed output," each relay turns ON for the same amount of time.

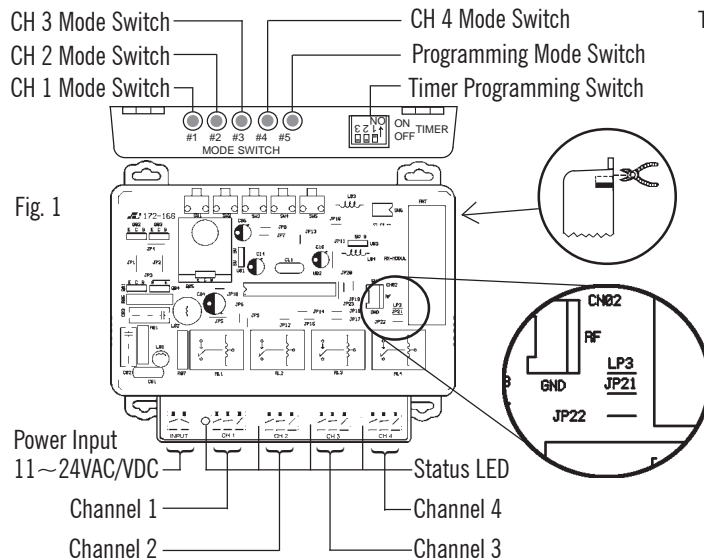

Table 1- Timer Programming Switch Setting.

Sec.	SW1	SW2	SW3
1*	On	Off	Off
2	Off	On	Off
3	Off	Off	On
4	On	Off	On
5	Off	On	On
10	On	On	Off
30	Off	Off	Off
60	On	On	On

\* Default Setting

If optional antenna is used LP3 must be cut and the antenna slot on the receiver case must be chip off to accommodate the extended range antenna wire (see Fig. 1).

## Channel Mode Switch Operation (one per channel)

- Learn mode — Press and hold the switch for three seconds or more.
- Clear memory — Press and hold the switch for three seconds or more, then when the LED starts flashing, press again for three seconds to delete all previously learned codes.
- Reset latched output — If this channel was programmed for latch output, once the relay is turned on with a transmitter button, press the mode switch of that channel once to turn the relay OFF.
- Memory Display — Press and release the mode switch to show the number of codes stored. The LED will flash a number of times corresponding to the number of codes stored.

## LED Indication (one per channel)

- Steady ON — Senses signal from a transmitter button or indicates a transmitter button's code already exists in the receiver's memory during code learning.
- Fast flash — In the code-learning mode or channel memory display mode, or during the programming channel output mode.
- One flash — A transmitter button's code was learned, or the relay is in time output mode.
- Two flashes — All previously learned transmitter button codes were deleted, or the relay is in toggle output mode.
- Three flashes — Latched output.
- Four flashes — Validity output.
- 0~15 flashes — In the normal operation mode, pressing the channel mode switch (1~4) once will display the number of codes learned.

## Extended Range Antennas

Two antennas are available to extend the range of the SK-910R4Q receiver:

**SK-91ERSWQ** Extends RF receiver range up to 800 feet (open air) with existing remotes.

**SK-91ERSDQ** Extends RF receiver range up to 1,200 feet (open air) with existing remotes.

These antennas come with a 9' cable which easily plugs into the 3-pin antenna port located on the RF receiver.

- Note:** a) If an extended range antenna is used, the "LP3" on the receiver PC board must be cut.  
b) Actual antenna range will vary greatly depending on the operating environment.



## Typical Applications:

### Positive Output:

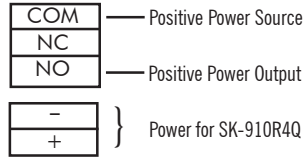

### Negative Output:

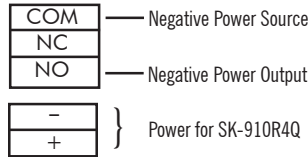

### 11~24 VAC/VDC power input, 24VAC output driving a motor:

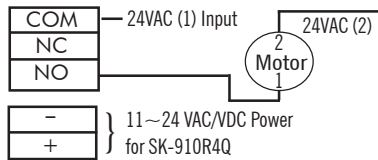

### 11~24 VAC/VDC power input, 24VDC output driving a motor:

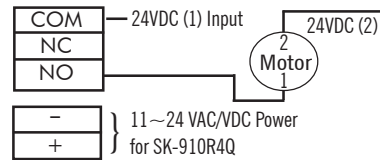

### 12VDC power input, 12VDC positive output:

#### Typical N.C. application (access control).

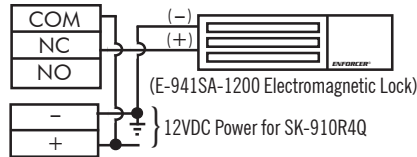

### 12VDC power input, 12VDC positive output:

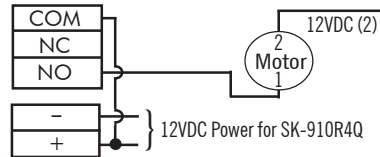

## General Specifications

Operating Frequency:	315MHz ( SK-910R4Q ), 433.92MHz ( SK-910R4-4Q )
Memory Capacity:	15 transmitter button codes per channel, 60 per receiver.
Operating Voltage:	11VDC ~ 24VDC or 11VAC ~ 24VAC
Operating Current:	8 mA @ 12VDC (standby), 30mA/channel @ 12VDC (activated)
Relay Contact Rating:	Form 'C' type; 10A @ 24VDC or 120VAC per channel
Connectors:	Screw Terminals, +, -, with N.O., N.C., and COM per channel
Dimensions:	5.3" x 3.9" x 1.1" (135 x 100 x 27.5 mm)

## Compatible Transmitters

Fixed-Code: 68 billion codes.

CODEBUMP™: 18 quintillion (1.8 x 10<sup>19</sup>) codes

315MHz	433.92MHz
SK-919 Series Fixed Code	SK-939 Series Fixed Code
SK-917 Series CODEBUMP	SK-937 Series CODEBUMP

**WARRANTY:** This SECO-LARM product is warranted against defects in material and workmanship while used in normal service for a period of one (1) year from the date of sale to the original consumer customer. SECO-LARM's obligation is limited to the repair or replacement of any defective part if the unit is returned, transportation prepaid, to SECO-LARM.

This Warranty is void if damage is caused by or attributed to acts of God, physical or electrical misuse or abuse, neglect, repair, or alteration, improper or abnormal usage, or faulty installation, or if for any other reason SECO-LARM determines that such equipment is not operating properly as a result of causes other than defects in material and workmanship.

The sole obligation of SECO-LARM, and the purchaser's exclusive remedy, shall be limited to replacement or repair only, at SECO-LARM's option. In no event shall SECO-LARM be liable for any special, collateral, incidental, or consequential personal or property damages of any kind to the purchaser or anyone else.

**NOTICE:** The information and specifications printed in this manual are current at the time of publication. However, the SECO-LARM policy is one of continual development and improvement. For this reason, SECO-LARM reserves the right to change specifications without notice. SECO-LARM is also not responsible for misprints or typographical errors.

Copyright © 2006 SECO-LARM U.S.A., Inc. All rights reserved. This material may not be reproduced or copied, in whole or in part, without the written permission of SECO-LARM.

SECO-LARM® U.S.A., Inc.

16842 Millikan Avenue, Irvine, CA 92606

Tel: 800-662-0800 / 949-261-2999 Fax: 949-261-7326

Website: [www.seco-larm.com](http://www.seco-larm.com)

E-mail: [sales@seco-larm.com](mailto:sales@seco-larm.com)

FILE: DT/DTP/MtISk9104Q\_06A.pmd

ORDER PART# 762-100-1%

PITSW1