

## Quick Reference Guide

### 1. Using the User Codes:

A. User codes operate the door (4-8 digits long).

Press **u u u u**

B. The **#** key must be pressed also if the keypad is in manual-entry mode.

Press **u u u u #**

### 2. Using the Master Code:

The Master Code can be used to operate the door or program the keypad (4-8 digits long, see pt. 5 below).

Press **x x x x # 1** (Relay output #1)

Press **x x x x # 2** (Relay output #2)

### 3. Using the Inhibit/Lockout Code:

Please contact your installer for an explanation of inhibit mode and its operation.

### 4. Using Duress Codes:

For a full explanation of duress codes and their uses, see pg. 12.

### 5. Delete/Add/Change User and Master Code:

**WARNING — Press the correct option key. If the option key is not used and a "0" is pressed after entering the Master Code, it could accidentally reprogram the Master Code.**

A. Enter the Master Code first, followed by the **x** key

(If you forgot the master code, see page 15 for more information.)

Press **x x x x x**

B. Changing/Adding Users:

Press **1** 00-99 (user ID) **u u u u** (user code, 4-8 digits) **#** (for relay output #1)

Press **2** 0-9 (user ID) **u u u u** (user code, 4-8 digits) **#** (for relay output #2)

C. Deleting Individual Users:

Press **1** 00-99 (user ID) **#** (for relay output #1)

Press **2** 0-9 (user ID) **#** (for relay output #2)

D. Changing the Master Code:

Press **0** **x x x x** **#**

E. To exit programming mode, press the **x** key.

Note: **u u u u** indicates the user code.

Note: **x x x x** indicates the master code.

# ENFORCER®

## SK-1123-SQ

### Outdoor Digital Access Keypad with 2 Outputs

## MANUAL



**LIFETIME LIMITED WARRANTY** This SECO-LARM product is warranted against defects in material and workmanship while used in normal service for the lifetime of the product. SECO-LARM's obligation is limited to the repair or replacement of any defective part if the unit is returned, transportation prepaid, to SECO-LARM. Under no circumstances will SECO-LARM be responsible for any costs or charges for removal, installation, or reinstallation. This Warranty is void if damage is caused by or attributed to acts of God, physical or electrical misuse or abuse, neglect, repair, or alteration, improper or abnormal usage, or faulty installation, or if for any other reason SECO-LARM determines that such equipment is not operating properly as a result of causes other than defects in material and workmanship. The sole obligation of SECO-LARM, and the purchaser's exclusive remedy, shall be limited to repair or replacement only, at SECO-LARM's option. In no event shall SECO-LARM be liable for any special, collateral, incidental, or consequential personal or property damages of any kind to the purchaser or anyone else. This lifetime limited warranty is for products sold and installed in the United States and Canada. For all other countries the warranty is 1 (one) year.

**NOTICE:** The information and specifications printed in this manual are current at the time of publication. However, the SECO-LARM policy is one of continual development and improvement. For this reason, SECO-LARM reserves the right to change specifications without notice. SECO-LARM is also not responsible for misprints or typographical errors. Copyright © 2010 SECO-LARM U.S.A., Inc. All rights reserved. This material may not be reproduced or copied, in whole or in part, without the written permission of SECO-LARM.

**SECO-LARM® U.S.A., Inc.**

16842 Millikan Avenue, Irvine, CA 92606

Tel: 800-662-0800 / 949-261-2999 Fax: 949-261-7326

Website: [www.seco-larm.com](http://www.seco-larm.com)

E-mail: [sales@seco-larm.com](mailto:sales@seco-larm.com)

PIHAK1

MISK-1123-SQ\_092810.pmd

**SECO-LARM U.S.A., Inc.**

Also available from SECO-LARM:

Indoor Keypads



SK-1011-SQ

SK-1131-SQ

Outdoor Keypads



SK-1123-FQ

SK-2323-SDQ

SK-1323-SDQ

**SLI® SECO-LARM®**



Note: Model numbers that end with "Q" or that have a round green "Q" sticker signify RoHS-compliant products.

**TABLE OF CONTENTS**

Introduction ..... 2  
 Dimensions ..... 2  
 Unique features ..... 3  
 Programming backlit control ..... 4  
 Wiring - Basic diagram ..... 4  
 Specifications ..... 5  
 Wiring — Example, with inhibit control authorized ..... 6  
 Door-Hold-Open ..... 7  
 Wiring — Example, with connection to lock device and alarm arm/disarm ..... 7  
 List of user codes worksheet ..... 8,9  
 Wiring — Mantrap using two keypads ..... 10  
 Wiring — Auxiliary accessories ..... 11  
 Programming notes ..... 12  
 LED and buzzer indicators ..... 12  
 Preparing to Program, Getting Started, and User programming ..... 13  
 Installer programming ..... 14  
 Reprogram the keypad (certain data) ..... 15  
 Reprogram the keypad (complete data refresh) ..... 15  
 Delete user ..... 15  
 Master code bypass (DAP jumper) ..... 15  
 Quick reference guide ..... 16

**INTRODUCTION**

The SK-1123-SQ is the ideal keypad for office, commercial, and home security installations. This self-contained security keypad has a built-in 5-Amp relay output and a 1-Amp relay output for maximum flexibility when connecting to electronic door strikes, door alarms, door chimes, alarm control panels, or other security and access control applications. The outputs can be programmed for timed (1-999 seconds) or ON/OFF operation. The SK-1123-SQ can be programmed for up to 100 4-digit to 8-digit user codes for the primary output, and up to 10 4-digit to 8-digit user codes for the second output. All programming and code information is stored in non-volatile EEPROM memory to protect the data in case of power loss.

**DIMENSIONS**

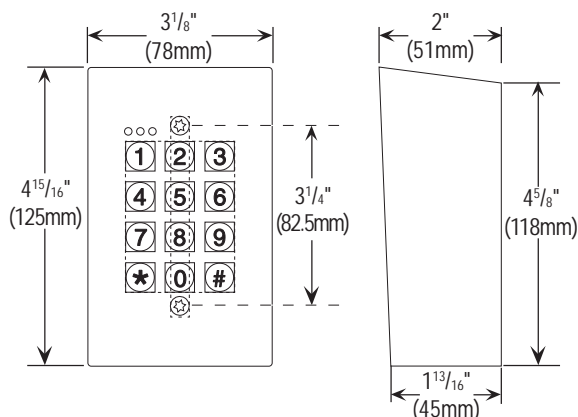

**PARTS LIST**

- Keypad x 1
- Back box x 1
- Diode x 1
- Installation screws x 3
- Mounting screws x 2
- Security wrench x 1

**REPROGRAM THE KEYPAD (CERTAIN DATA)**

To change certain data in the keypad (such as to delete or change user codes), do the following:

1. Enter program mode by keying in the master code and the [\*] key:  
 [X][X][X][X] [\*] The keypad is now in the programming mode.
2. Use the programming instructions on page 13 and 14 to make any changes to the keypad's data.
3. Exit the programming mode by pressing the [\*] key.

**REPROGRAM THE KEYPAD (COMPLETE DATA REFRESH)**

Sometimes it may be necessary to completely erase all current data (except the master code) and input new data. An example of when this may be necessary is the sale of a protected building to a new owner. In such a situation, do the following:

1. Enter the programming mode by keying in the master code and the [\*] key, then enter the refresh code, [8][9][0][1] and the [#] key:  
 [X][X][X][X] [\*] The keypad is now in the programming mode.  
 [8][9][0][1] [#] All old data is cleared and the keypad is ready for new data.

NOTE: The master code does NOT change.

2. Use the programming instructions on pages 13 and 14 to enter the keypad's data.
3. Exit the programming mode by pressing the [\*] key.

**DELETE USER**

To delete a user who has left the company or who no longer has authority to enter the protected area:

1. Enter program mode by keying in the master code and the [\*] key:  
 [X][X][X][X] [\*] The keypad is now in the programming mode.
2. Enter the output #, user ID number, and the [#] key:  
 To delete user D 05 from output #1, press [1][0][5][#].  
 To delete user D 1 from output #2, press [2][1][#].
3. Exit the programming mode by pressing the [\*] key.

**MASTER CODE BYPASS (DAP jumper)**

If the master code is forgotten or does not work, use the DAP (direct access to program) jumper to override the forgotten code and permit direct entry into the programming mode as follows:

1. Disconnect the power supply.
2. Move the DAP jumper from OFF to ON.
3. Reconnect the power supply.  
 The keypad will start beeping.
4. Move the DAP jumper back to the OFF position.  
 The keypad will stop beeping as soon as the jumper is removed.
5. The keypad is now in the programming mode, ready to receive new programming data.
6. Re-program the keypad as shown starting on page 13.

**NOTE** — A new master code may be programmed to replace the one that was lost or forgotten. Note that the sequence for replacing the old master code is as follows:

Option\*    Key in new code    Confirm    Exit  
 [0]            [X][X][X][X]        [#]            [\*]

\*Zero "0" is for new master code only; see page 13 for other options.

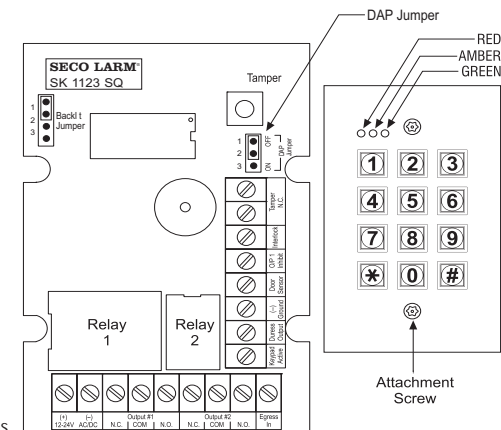

**INSTALLER PROGRAMMING**

These functions should only be used by professional installers, as incorrect entries can disable the entire keypad function.

**Enter Programming Mode**

Enter Master code    Confirm    Function  
 [X][X][X][X] \*    Enter into programming mode

\*Key in the Master Code.

Note: For first-time use, Master code is 0000

Note: After entering programming mode, proceed to desired programming option

(DEFAULT: 0000)

**Data Refresh**

Op ion    Confirm    Function  
 8901 #    Clears all previously stored data.

**Configure Relay Outputs**

(DEFAULT: Momentary, 1-sec. output for both outputs)

Option	Output ime	Confirm	Function
40	1 to 999	#	Relay #1, momentary mode, from 1 to 999 seconds
41		#	Relay #1, shunt mode (ON/OFF)
50	1 to 999	#	Relay #2, momentary mode, from 1 to 999 seconds
51		#	Relay #2, shunt mode (ON/OFF)

**Wrong Code Lockout**

(DEFAULT: 10 tries / 30 seconds)

Option	# of tries	Confirm	Function
70		#	After 10 successive wrong codes, 30-second lockout
71		#	After 10 successive wrong codes, Duress activated
72	5 to 10	#	After 5 to 10 wrong codes, 15-min. lockout - Can reset with Master Code
7600		#	None of the above

**Door-Forced-Open Alarm**

(DEFAULT: Disabled)

Op ion	Code entry	Confirm	Function
80	1	#	Door-forced-open alarm is enabled
	0	#	Door-forced-open alarm is disabled

**Door Unlocked Announcer**

(DEFAULT: On)

Option	Code entry	Confirm	Function
81	1	#	1-sec. beep notifies the user to open the door when the output relay is activated.
	0	#	The beep is disabled, replaced by 2 short beeps for valid user codes.

**User Code Entry Mode**

(DEFAULT: Manual)

Op ion	Code entry	Confirm	Function
82	1	#	<b>Auto Entry Mode</b> is selected. The [1] key that follows the user code is NOT required in code entry. The User Codes MUST be set to the same digit length as the Master Code.
	0	#	<b>Manual Entry Mode</b> is selected. The [0] key that follows the user code is required in code entry. The User Codes can be 4-8 digits, but not necessarily all of the same length.

**Keypress Beeps**

(DEFAULT: On)

Op ion	Code entry	Confirm	Function
83	1	#	Keypad beeps when a key is pressed.
	0	#	Silent operation -- keypad does not beep when a key is pressed.

**LED Flashes in Standby Mode**

(DEFAULT: On)

Code entry	Confirm	Function	
84	1	#	Amber LED ON during standby mode.
	0	#	Amber LED OFF during standby mode.

**Door-Propped-Open Alarm Timer**

(DEFAULT: Off)

Code entry	Confirm	Function	
9	0	#	No door-propped-open alarm
	1 to 999	#	Allowable time from 1 to 999 seconds that the door can be left open before the alarm starts.

**Exit Programming Mode**

Confirm	Function
*	Exits programming mode, returns keypad to normal operations

**UNIQUE FEATURES**

- **12-24V AC/DC universal power** – No programming or jumpers needed.
- **Mantrap** – Each keypad can be used as a stand-alone keypad. However, the mantrap feature uses two keypads to protect an area with two doors by ensuring that only one door is open at a time. With the mantrap interlock functions, when a user keys in the code to open one door, a signal is sent to disable the second keypad, thereby preventing access through the second door until the first door is closed.
- **Relay output #1 inhibit control** – Relay output #1 is typically used for a door strike. If the keypad is set to the "inhibited" mode, relay output #1 will not operate. This increases the security of the protected premises during the time it is not expected to be occupied, such as during evening or weekend hours. An authorized user can enable or disable the inhibit control by using the code for relay output #2 at any time, depending on how installed.
- **Door-forced-open warning** – When used with an optional magnetic contact, the keypad beeps continuously if the door to the protected premises is forced open without using a valid user code. The warning can be stopped only by closing the protected door.
- **Door-propped-open warning** – When used with an optional magnetic contact, the keypad beeps continuously if the door is propped open after the allowed open time. The allowable open time is programmable. The warning stops when the door is re-closed.
- **Door-hold-open mode** – Output #2 can be programmed to hold the door open if it needs to remain open for an extended length of time.
- **Auto or manual code entry checking:**
  - Auto code entry checking mode – When all the user codes have the same number of digits, the keypad will activate automatically when the code is entered. There is no need to press the "#" key. This is convenient for the users.
  - Manual code entry checking mode – The user codes can vary in number of digits, and the user must press the "#" key when finished entering the code. This increases security.
- **Keypad active output** – This NPN transistor open collector ground (-) output activates for 10 seconds when any key on the keypad is pressed. This can be used to trigger a video recorder or turn on a light, or to signal a guard that someone is entering the protected premises.
- **Door auto relock** – The keypad will relock an open door either when the relock time expires or immediately after the door is closed, depending on which occurs first. This prevents unwanted "tailgate" entries, which can happen if an unauthorized person tries to follow an authorized person through the door.
- **Duress output** – This NPN transistor open collector ground (-) output can be used to trigger a silent alarm if an authorized user is forced under duress to use the keypad. The duress output is activated by adding 2 to the first digit of user code 1. In this case, the protected door opens as it would normally, but a signal is quietly sent to a remote device to call for help without alerting the unauthorized person.
- **Backlit keypad** – The keypad is backlit to increase nighttime visibility. The backlit function can be programmed via a jumper for full, partial or no illumination.

WIRING, BASIC DIAGRAM

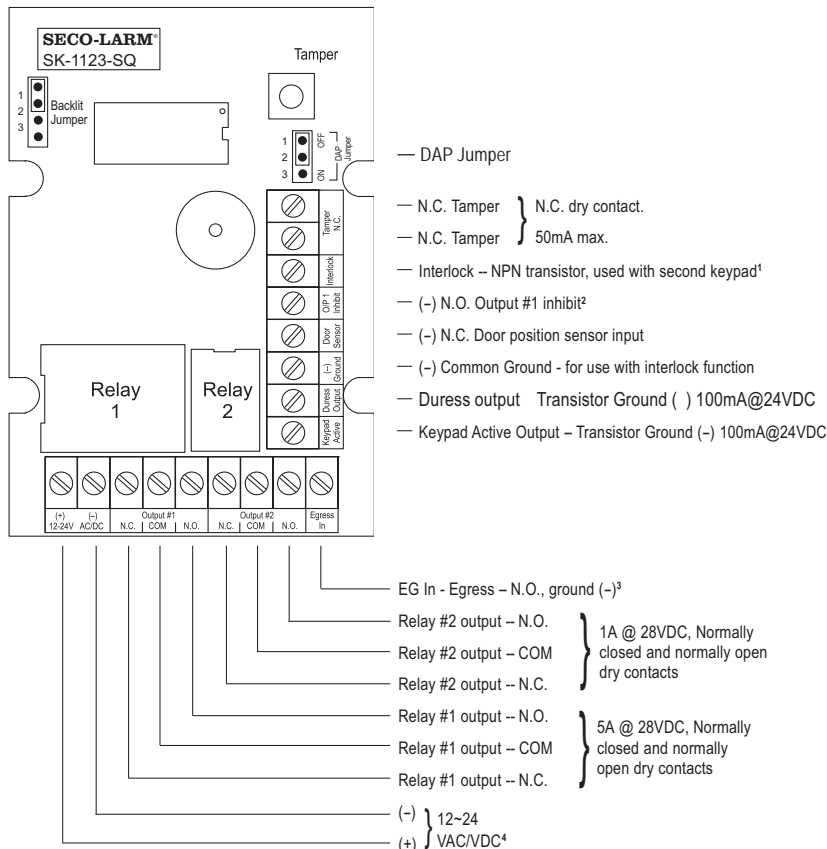

BACKLIT JUMPER

Setting	Jumper Position	Description
FULL (default)		<ul style="list-style-type: none"> <li>Keypad standby mode is dimly backlit.</li> <li>Keypad brightens to full illumination for 10 seconds after each key is pressed, then returns to dim backlit (standby mode).</li> </ul>
AUTO (QUASI)		<ul style="list-style-type: none"> <li>Keypad standby mode is no illumination.</li> <li>Keypad brightens to full illumination for 10 seconds after each key is pressed, then returns to no illumination (standby mode).</li> </ul>
OFF		<ul style="list-style-type: none"> <li>Keypad has no backlit illumination at any time.</li> </ul>

<sup>1</sup> Mantrap control output – Outputs ground (-) for five seconds after relay output #1 is activated, continues while the door is open.  
<sup>2</sup> Connect to ground (-) to prevent relay output #1 from operating, or to the mantrap (interlock) control output of another keypad to disable output #1 while the other keypad is active.  
<sup>3</sup> Connect to optional N.O. push button or switch.  
<sup>4</sup> For DC, connect to a regulated power supply with correct polarity, + to +, - to -. For AC, polarity is not important.

PREPARING TO PROGRAM THE KEYPAD

To program the SK-1123-SQ, first determine the following information:

1. The master code -- Allows the system administrator to program or operate the keypad.
2. The user code or codes -- Allows users to use the keypad's functions.
3. Configuration of the relays and outputs -- For relay output #1 and relay output #2, determine whether the output should operate from 1 to 999 seconds and then turn OFF (momentary mode), or turn ON/OFF via the code (shunt mode).
4. Result of improper code entry (optional) -- Choose between a 30-second code lockout, duress output, a 15-minute code lockout, or no reaction.

\* Note: When  appears in the instructions, it indicates master code entry.

GETTING STARTED

A master code is required to program the keypad. The default master code is set to "0000." To change a forgotten master code, go to page 15 and follow the instructions for "MASTER CODE BYPASS" (DAP jumper).

Once the master code is set, review the programming options and decide exactly what the keypad will do, including the format of the user access codes as well as how the keypad responds via the relay output, buzzer and LEDs. Note that in every case the basic steps for programming are:

1. Enter the master code, followed by the  key, which puts you in programming mode.
2. Enter the programming options defined in the various sections as needed, followed by the  key.
3. Enter the  key again to exit programming mode.

Note: A rapid string of 5 beeps and/or 5 LED flashes indicates an error, while 2 beeps indicates that the entry has been accepted.

USER PROGRAMMING

ENTER PROGRAMMING MODE

Enter Master code	Confirm	Func ion
<input type="text" value="XXXX"/>	<input type="text" value="*"/>	Enter into programming mode

Note: For first-time use, Master code is

ADDING OR CHANGING MASTER AND USER CODES

**WARNING** – Press the correct option key. If the option key is not used and a "0" is pressed after entering the Master Code, it could accidentally reprogram the Master Code.

Option	User ID	Access code	Confirm	Func ion
<input type="text" value="0"/>		4 to 8 digits	<input type="text" value="#"/>	Change Master Code
<input type="text" value="1"/>	00 to 99	4 to 8 digits	<input type="text" value="#"/>	Set/change up to 100 User Codes for relay output #1, with duress feature
<input type="text" value="2"/>	0 to 9	4 to 8 digits	<input type="text" value="#"/>	Set/change up to 10 User Codes for relay output #2

Note: No user code may be the same as the master code.

Note: For User ID, key in the number of the user. For Access Code, type in the code for that particular user.

DELETE A USER

To delete a user who has left the company or who no longer has authority to enter the protected area:

1. Enter programming mode:

Enter Master code	Confirm	Func ion
<input type="text" value="XXXX"/>	<input type="text" value="*"/>	Enter into programming mode

2. Delete code:

Option	User ID	Confirm	Func ion
<input type="text" value="1"/>	00 to 99	<input type="text" value="#"/>	Deletes specific user ID from output #1
<input type="text" value="2"/>	0 to 9	<input type="text" value="#"/>	Deletes specific user ID from output #2

EXIT THE PROGRAMMING MODE BY PRESSING THE "\*" KEY

**PROGRAMMING NOTES**

**1. Master Code:** The SK-1123-SQ comes pre-programmed with the Master Code set at 0000. Additional codes and/or data should be programmed at the owner's discretion. However, to ensure security, program a new personal Master Code to replace the factory-set Master Code as soon as possible.

**2. Factory defaults:**

Master code	0000
User code length	4-8 digit
Main relay output time	1 second
Auxiliary relay output time	1 second
Wrong code lockout	10 tries / 30 sec.

Door-forced-open alarm	disabled
Door unlocked annunciator	ON
User code entry mode	manual
Keypress beep	ON
Door-propped-open alarm	OFF
Silent operation	OFF

**3. Code operation:** User codes are each four to eight digits and are assigned to two-digit IDs. If all the codes have the same number of digits, the keypad can be programmed for whether the [E] key must be used or not after entering the code (see programming, option 82, page 14).

The administrator can easily delete the code of one user via the two-digit ID, if the user is no longer authorized to enter a protected area, without the need to teach the new code to all the other users.

Relay output #1 allows up to 100 user codes, and relay output #2 allows up to 10 user codes.

**4. Using Duress Codes (Relay #1 only):** Duress codes are used to activate a separate device silently to alert a guard or other personnel that a user is operating the keypad under threat. The keypad operates as normal, but a signal is sent to alert others.

Duress codes do not need to be programmed. All user codes are automatically turned into duress codes by increasing the first digit of a user code by the number 2. The code is entered the same way as a regular user code.

For example:

User code 4468 can be entered as duress code 6468

User code 9843 can be entered as duress code 1843

User code 8181 can be entered as duress code 0181

NOTE: If a user code is programmed, its duress code is unique and cannot be programmed as another user code. For example:

If user code 4468 is programmed, its duress code of 6468 is automatically programmed. A user code of 6468 cannot be programmed.

**Note:** Once activated, the duress output continues until a correct user code is entered.

**LED INDICATORS**

- Red LED -- Lights while output #2 is activated.
- Amber LED -- Flashes to show the keypad status (see below).
- Green LED -- Lights while output #1 is activated.

**BUZZER AND LED SIGNALS**

The keypad's built-in buzzer and the amber LED can signal the following:

STATUS	BUZZER TONES*	AMBER LED FLASHES
1. In programming mode	- - -	ON
2. Successful key entry	1 beep	1 flash
3. Successful code entry	2 beeps	2 flashes
4. Unsuccessful code entry	5 beeps	5 flashes
5. DAP jumper not replaced	Continuous beeps	Continuous flashes
6. In standby mode	- - -	1 flash in 2-sec. intervals
7. Output relay activated	1-sec. long beep**	- - -

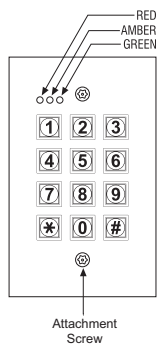

NOTE: \* The buzzer can be disabled through programming option 83, ref. pg. 14.

\*\* The output relay activated beep can be disabled through programming option 81, ref. pg. 14.

**SPECIFICATIONS**

**Power:**

- Operation voltage -- 12-24 Volts AC/DC. No jumper needed to set voltage.
- Stand-by current drain -- 15mA @12VDC.
- Active current drain (press keypad key) -- Under 45mA@12VDC.
- Active current drain (one relay activated) -- Under 80mA@12VDC.
- Active current drain (two relays activated) -- Under 130mA@12VDC.

**Outputs:**

- Relay output #1 -- 5A @ 28VDC, Form "C", N.O./C./N.C., programmable for 1 to 999 second timed output or shunt (start/stop) output. Three terminals.
- Relay output #2 -- 1A @ 28VDC, Form "C", N.O./C./N.C., programmable for 1 to 999 second momentary output or shunt (start/stop) output. Three terminals.
- Keypad active or alarm output -- Transistor ground max. 100mA @ 24VDC. Switches to ground (-) for 10 sec. when a key is pressed (keypad active output), or switches to ground (-) to indicate a door was forced open or propped open (alarm output). Single terminal.
- Mantrap (interlock) control output -- Outputs ground (-) for five seconds after relay output #1 is activated, continues while the door is open. Use to disable a second keypad during this time. Single terminal.
- Duress output -- Transistor ground (-), 100mA @ 24VDC. If switches to ground (-) after the duress code is entered. Single terminal.

**Inputs:**

- Power -- 12-24Volts AC/DC. Two terminals.
- Egress -- N.O., ground (-). Single terminal.
- Door sensor input -- N.C., ground (-). Connect to an N.C. magnetic contact to show if door is opened or closed, or connect to ground (-) if not used. Single terminal.
- Relay output #1 disable input -- Connect to ground (-) to prevent relay output #1 from operating, or to the mantrap (interlock) control output of another keypad to disable output #1 while the other keypad is active. Single terminal.

**Other Features:**

- Tamper -- 50mA @ 12VDC, N.C. dry contact. Connect to tamper circuit of alarm control panel. Two terminals.
- Ground -- Steady ground (-), 100mA @ 24VDC. Single terminal.

**Code Operation:**

- Auto or manual code entry. Up to 100 user codes for relay output #1, up to 10 user codes for relay output #2. 111,110,000 possible user code combinations.

**Auto refresh time during code entry:**

- Max. 10 seconds to enter each digit.
- Max. 30 seconds to enter each code.

**Dimensions (keypad with back box):**

- 4-15/16" x 3-1/8" x 2" (125 x 78 x 51 mm).

**Weight**

- 18 oz. (510 grams).

**WIRING:**

Example Wiring, with Inhibit Control Authorized

CONNECTIONING INHIBIT AUTHORIZATION CONTROL

**WARNING**

- For safety, ensure that no one is inside the premises before starting the door lock inhibit function. During inhibit, doors remain locked.

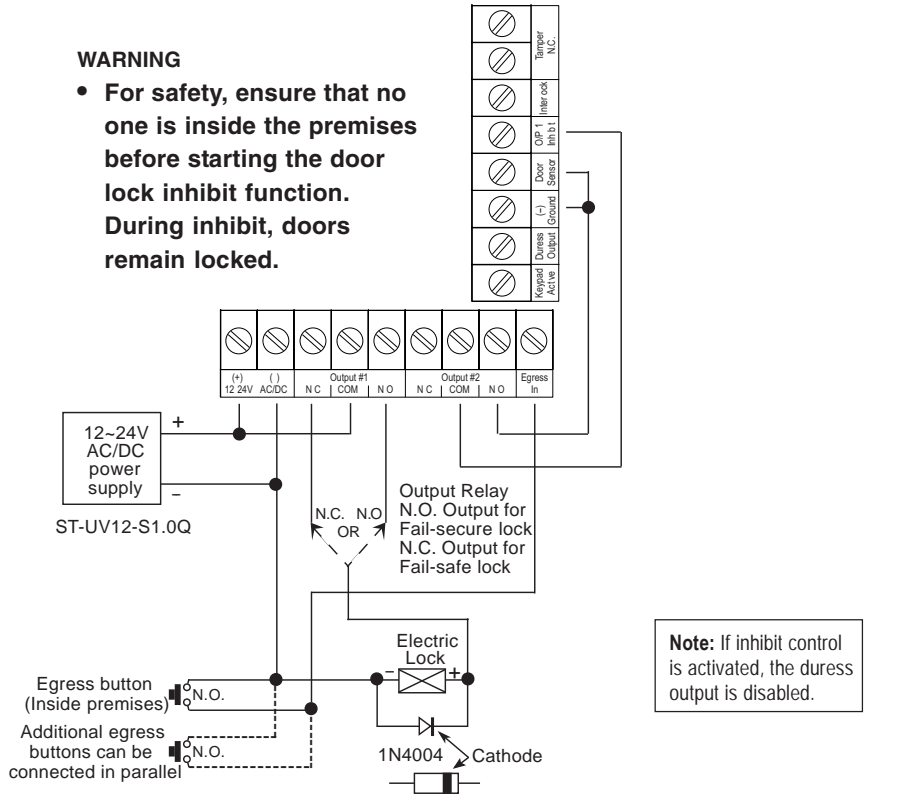

- Connect a 1N4004 diode as close as possible to and in parallel with the DC-powered electromagnetic or electric lock. This absorbs possible electromagnetic interference to prevent operation of the lock from damaging the keypad. A 1N4004 is not required for AC-powered locks.
- Connect the ground (-) terminal of the keypad to earth to prevent electrostatic discharge from damaging the keypad.
- The connection of relay output #1 disable to output #2, as shown above is optional. When so wired, output #2 is the inhibit control. To use, program output #2 for shunt on/off operation. When output #2 is ON, relay output #1 will not work. For example, this can be used to prevent users from entering the protected premises during the evening or weekend. See programming option 61.
- The green LED lights while relay output #1 is activated to activate the lock.
- The red LED lights to show that relay output #1 is disabled by the activation of output #2.
- Tape all unused wires to prevent short circuits.

**WARNING:**

- If the inhibit control is used, all personnel must exit the protected premises before output #2 is activated. Otherwise, personnel in the protected premises will not be able to exit until output #2 is turned OFF.
- The user code for output #2 in this case should be given only to personnel authorized to enter the premises any time. It should not be given to other users.

**WIRING:**

Auxiliary Accessories

**TAMPER N.C.**

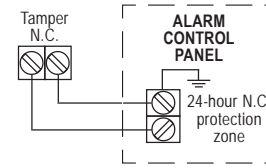

**DURESS OUTPUT**

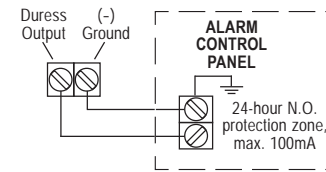

**DOOR SENSING**

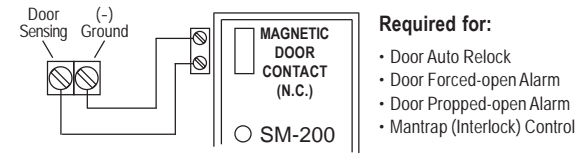

**KEY ACTIVE or ALARM OUTPUT**

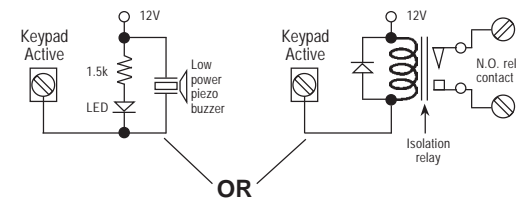

The Key Active Output will switch to ground (-) for 10 seconds whenever a key is touched. Use to turn ON an LED and/or a small buzzer to notify a guard, or to energize a relay to switch ON lights or CCTV camera. Only one connection option is recommended. Make sure the current sink does not exceed the maximum rating of 100mA. An external power supply and isolation relay are necessary to drive high power devices such as lights or CCTV cameras.

**RELAY OUTPUT #2 -- Example, to shunt an alarm N.C. zone**

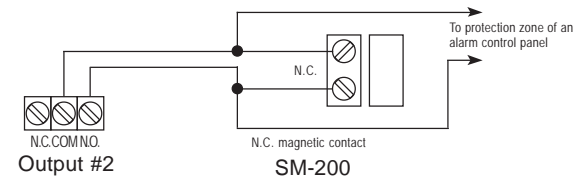

Use Normally Open (N.O.) output remove to shunt a Normally Closed (N.C.) protection zone of an alarm system. Set relay output #2 to Start / Stop mode (programming option 51)

**WIRING:**

Example Wiring, 2 Keypads with Mantrap

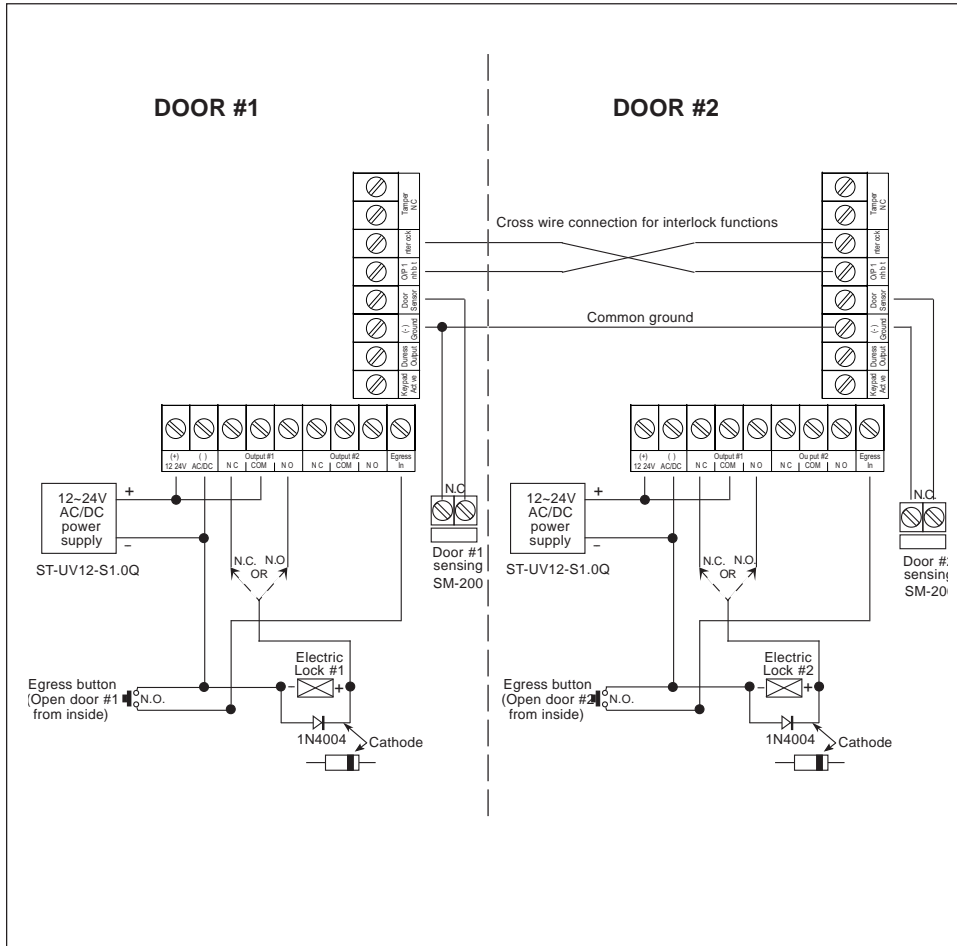

**Interlock** -- Each keypad can be used as a stand-alone keypad. The mantrap feature is for a protected area with two doors to ensure only one door is open at a time. With the mantrap feature, when a user keys in the code to open one door, a signal is sent to the second keypad to disable it, thereby preventing access through the second door until the first door is closed.

**Note: PLEASE ALSO REFER TO THE NOTES ON PAGE 6 FOR MORE GENERAL INFORMATION.**

- Use an N.C. magnetic contact or some other N.C. device to detect whether a door is opened or closed. Do this for the two entrances to the protected premises.
- Combine this wiring diagram with the diagram on page 7 if connection to an alarm control panel is required.
- Connect output #2 to relay output #1 disable as shown on page 6 if inhibit control is required.
- To use the mantrap feature:
  - o Use either the keypad from outside or the egress button from inside the protected premises to open one of the two doors.
  - o While the first door is opened, the first keypad sends a signal to the second keypad to prevent the second keypad from being used to open the second door.
  - o After the first door is closed, both keypads are ready to use.

**Door-Hold-Open Mode**

- **For N.C. locking devices:** Connect output 2 in series with the locking device.

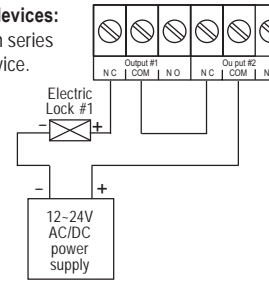

- **For N.O. locking devices:** Connect output 2 in parallel with the locking device.

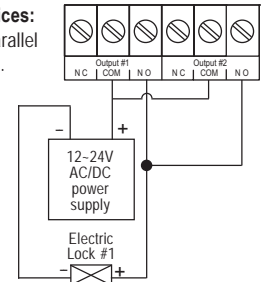

**WIRING:**

Example Wiring, with Connection to Lock Device and Alarm Arm/Disarm

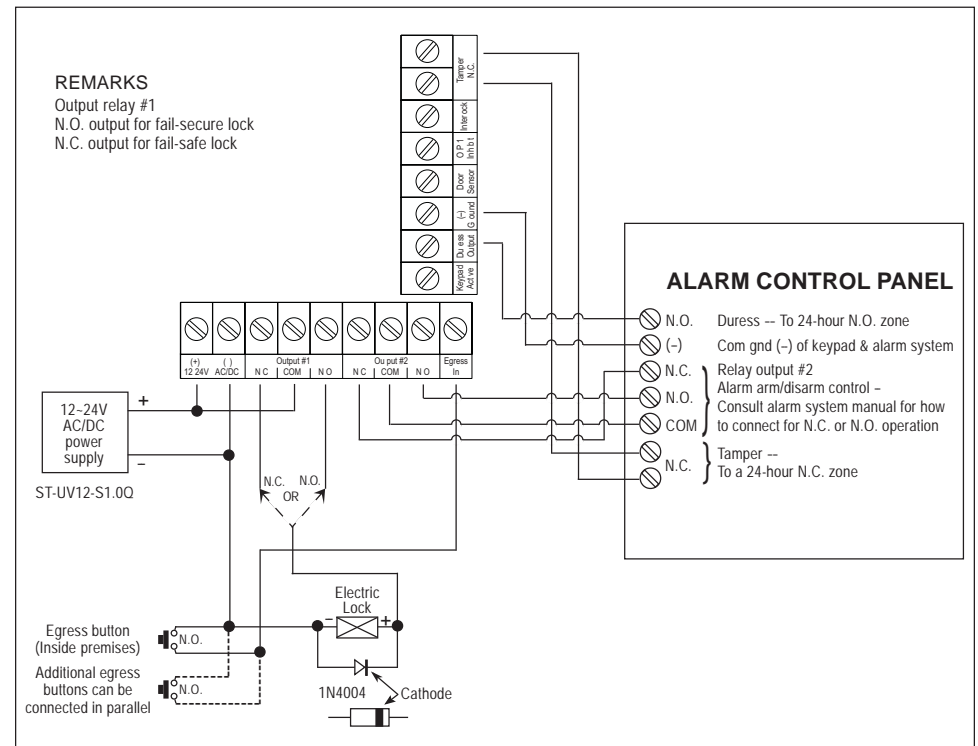

**Note:**

**PLEASE ALSO REFER TO THE NOTES ON PAGE 6 FOR MORE GENERAL INFORMATION.**

- The electromagnetic or electric door lock operation is the same as page 6.
- Relay output #2 controls the arm/disarm of the alarm control panel. Consult the alarm control panel manual for more information.
- Connect the duress output to a 24-hour N.O. zone and the tamper output to a 24-hour N.C. zone on the alarm control panel.
- The keypad's terminal ground (-) connects to the ground (-) wire of the alarm control panel to enable the two to work together.

# SK-1123-5Q - User Control Chart

Relay Output #1: Output: Shunt / Momentary (\_\_\_secs.) Programmed For

USER ID	User Name	Access Code
00	SAMPLE - John Doe	54321
00		
01		
02		
03		
04		
05		
06		
07		
08		
09		
10		
11		
12		
13		
14		
15		
16		
17		
18		
19		
20		
21		
22		
23		
24		
25		
26		
27		
28		
29		
30		
31		
32		
33		
34		
35		
36		
37		
38		
39		
40		
41		
42		
43		
44		
45		
46		
47		
48		
49		

USER ID	User Name	Access Code
00	SAMPLE - John Doe	54321
50		
51		
52		
53		
54		
55		
56		
57		
58		
59		
60		
61		
62		
63		
64		
65		
66		
67		
68		
69		
70		
71		
72		
73		
74		
75		
76		
77		
78		
79		
80		
81		
82		
83		
84		
85		
86		
87		
88		
89		
90		
91		
92		
93		
94		
95		
96		
97		
98		
99		

Relay Output #2: Output: Shunt / Momentary (\_\_\_secs.)

0	
1	
2	
3	
4	

Programmed For:

5	
6	
7	
8	
9	

Note: copy this sheet to use for your installations.