

Bluetooth® Post-Mount Keypad / Proximity Reader Product Specifications

SK-B941-PQ



What's in the Box:

1x SK-B941-PQ ENFORCER Bluetooth® Post-Mount Keypad / Reader

1x Eleven-Pin Removable Terminal Block 1x Diode 1x Varistor
 2x Keys* 1x Quick Installation/Setup Guide 1x Product Specifications

*No replacement keys available. Please make extra copies for safekeeping.

Specifications

Sample Wiring Diagram

Operating voltage	9-25 VDC	
Current draw	Standby	55mA@12VDC, 30mA@24VDC
	Active (max.)	100mA@12VDC, 55mA@24VDC
Outputs	Form C	2.0A@30VDC
	Tamper alarm	100mA@30VDC (solid state N.C.)
Egress input	N.O. Ground	
Door sensor input	N.C. Ground	
Proximity reader	EM 125kHz	
IP Rating	IP65 Weather-resistant	
PCB Protection	Waterproof, anti-corrosion coating	
Material	Housing	1/16" (1.2mm) Steel, powder paint
	Faceplate	Stainless steel
Operating humidity	0-95%, non-condensing	
Operating temperature	-4°~122° F (-20°~50° C)	
Dimensions	5"x6 1/16"x3 1/16" (128x170x94 mm)	
Weight	3-lb 3-oz (1.45kg)	

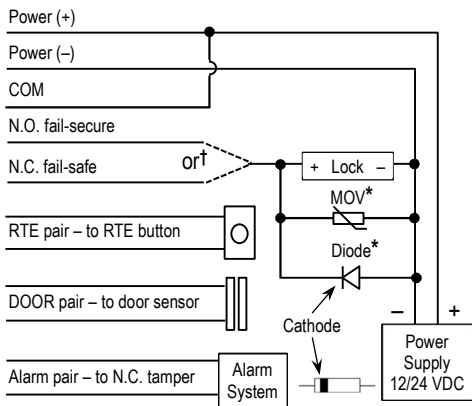

IMPORTANT NOTES

*To protect the relay, you must install the enclosed diode—with the cathode (striped end) toward the positive side—for DC powered locks **or** install the varistor (MOV,) for AC powered locks and for electromagnetic locks **unless your lock has a diode/MOV built in** (all SECO-LARM electromagnetic locks have built-in protection). Do not install both. Failure to install as directed will void the warranty. Download the *Installation Manual and Administrator Guide* from www.seco-larm.com for complete instructions.

†Use the N.O. terminal for fail-secure applications and the N.C. terminal for fail-safe applications.

ENFORCER Bluetooth® Post-Mount Keypad with Proximity Reader

Installation and Mounting

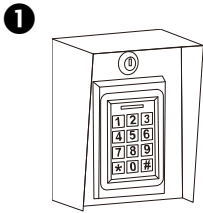

1. Unlock the Faceplate

Use one of the keys to unlock the faceplate.

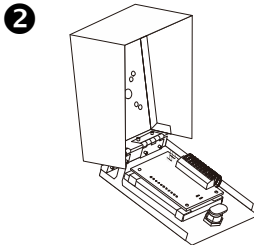

2. Open the Housing

Open to expose the mounting holes and PCB.

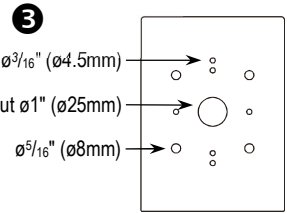

3. Wall Mount

For wall-mount, use the housing as a template to mark and drill holes.

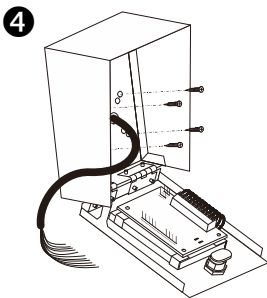

4. Mount the Housing

Push wires through the hole in the housing back and mount to wall or post.

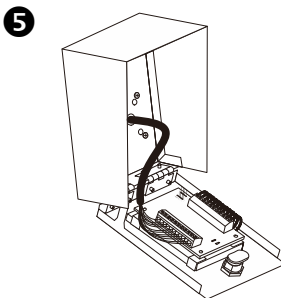

5. Connect the Wires

Using the diagram on pg. 1, connect the wires to the terminal block and plug the terminal block into the pins on the PCB.

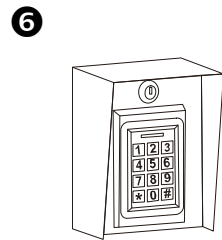

6. Close and Lock the Unit

Close the faceplate taking care not to crimp wires and lock into place.

The Bluetooth® word mark and logos are registered trademarks owned by Bluetooth SIG, Inc. and any use of such marks by SECO-LARM is under license. Other trademarks and trade names are those of their respective owners.

FCC/IC COMPLIANCE STATEMENT FOR BLUETOOTH MODULE

FCC ID: K7TRB8762

IC ID: 2377ARB8762

THIS DEVICE COMPLIES WITH PART 15 OF THE FCC RULES. OPERATION IS SUBJECT TO THE FOLLOWING TWO CONDITIONS: (1) THIS DEVICE MAY NOT CAUSE HARMFUL INTERFERENCE AND (2) THIS DEVICE MUST ACCEPT ANY INTERFERENCE RECEIVED, INCLUDING INTERFERENCE THAT MAY CAUSE UNDESIRABLE OPERATION.

Notice: The changes or modifications not expressly approved by the party responsible for compliance could void the user's authority to operate the equipment.

IMPORTANT NOTE: To comply with the FCC RF exposure compliance requirements, no change to the antenna or the device is permitted. Any change to the antenna or the device could result in the device exceeding the RF exposure requirements and void user's authority to operate the device.

This device complies with Industry Canada licence-exempt RSS standard(s). Operation is subject to the following two conditions: (1) this device may not cause interference, and (2) this device must accept any interference, including interference that may cause undesired operation of the device.

Le présent appareil est conforme aux CNR d'Industrie Canada applicables aux appareils radio exempts de licence. L'exploitation est autorisée aux deux conditions suivantes: (1) l'appareil ne doit pas produire de brouillage, et (2) l'utilisateur de l'appareil doit accepter tout brouillage radioélectrique subi, même si le brouillage est susceptible d'en compromettre le fonctionnement.

IMPORTANT WARNING: Incorrect mounting which leads to exposure to rain or moisture inside the enclosure could cause a dangerous electric shock, damage the device, and void the warranty. Users and installers are responsible for ensuring that this product is properly installed and protected from moisture.

IMPORTANT: Users and installers of this product are responsible for ensuring that the installation and configuration of this product complies with all national, state, and local laws and codes. SECO-LARM will not be held responsible for the use of this product in violation of any current laws or codes.

California Proposition 65 Warning: These products may contain chemicals which are known to the State of California to cause cancer and birth defects or other reproductive harm. For more information, go to www.P65Warnings.ca.gov.

WARRANTY: This SECO-LARM product is warranted against defects in material and workmanship while used in normal service for one (1) year from the date of sale to the original customer. SECO-LARM's obligation is limited to the repair or replacement of any defective part if the unit is returned, transportation prepaid, to SECO-LARM. This Warranty is void if damage is caused by or attributed to acts of God, physical or electrical misuse or abuse, neglect, repair or alteration, improper or abnormal usage, or faulty installation, or if for any other reason SECO-LARM determines that such equipment is not operating properly as a result of causes other than defects in material and workmanship. The sole obligation of SECO-LARM and the purchaser's exclusive remedy, shall be limited to the replacement or repair only, at SECO-LARM's option. In no event shall SECO-LARM be liable for any special, collateral, incidental, or consequential personal or property damage of any kind to the purchaser or anyone else.

NOTICE: The SECO-LARM policy is one of continual development and improvement. For that reason, SECO-LARM reserves the right to change specifications without notice. SECO-LARM is also not responsible for misprints. All trademarks are the property of SECO-LARM U.S.A., Inc. or their respective owners. Copyright © 2025 SECO-LARM U.S.A., Inc. All rights reserved.

SECO-LARM® U.S.A., Inc.

16842 Millikan Avenue, Irvine, CA 92606
Phone: (949) 261-2999 | (800) 662-0800

Website: www.seco-larm.com
Email: sales@seco-larm.com

CE (C) FC PITSW1
Order Part# 762-411-2%
MA_SK-8941-PQ_250206.docx