

Bluetooth® Access Controllers

Quick Installation/Setup Guide



Getting Started:



Download the *SL Access™* app from the corresponding store for your phone (iOS 11.0 and above, Android 5.0 and above).

Get the complete Installation Manual, *SL Access App User Manual*, and more at [SECO-LARM's website](#).

NOTES:

- Be sure to set your smartphone to automatically download app updates so that you always have the latest version of the app.
- The app will appear in your device's default language if available. If the app does not support your device language, it will default to English.

The *Bluetooth®* word mark and logos are registered trademarks owned by Bluetooth SIG, Inc. and any use of such marks by SECO-LARM is under license. Other trademarks and trade names are those of their respective owners.

ENFORCER Bluetooth® Access Controllers

Quick Installation:

This manual is for installers looking to do a basic installation and setup of the ENFORCER Bluetooth® keypad/reader (SK-B141-PQ shown, others similar).

Mounting and Installation

See the *Product Specifications* sheet included in your product for mounting and basic installation. For more in-depth installation and advanced programming instructions, see the corresponding product page at www.seco-larm.com and download the *Installation Manual and Administrator Guide*.

Basic Wiring Diagram

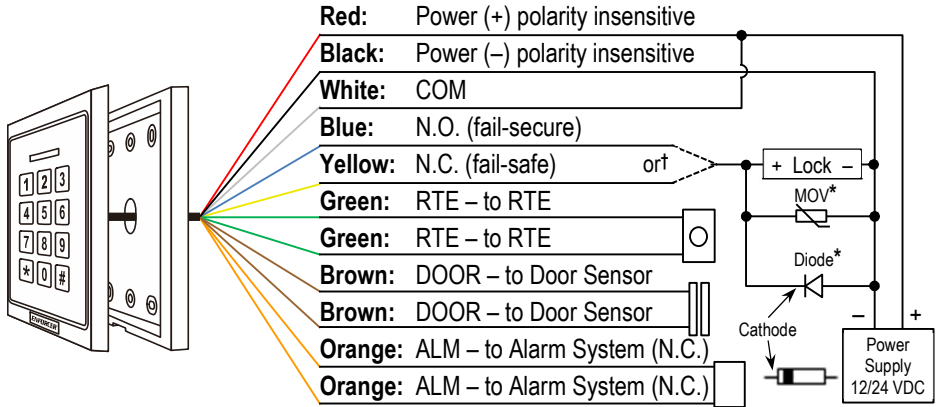

AC-Powered Lock Wiring

AC powered locks should be wired as follows. Their peripherals are wired the same as above.

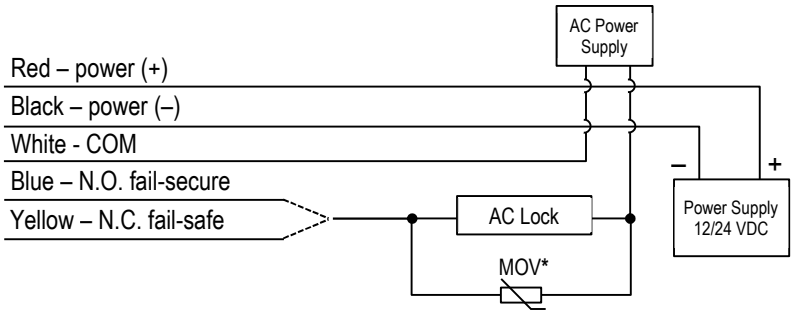

IMPORTANT NOTES:

*To protect the relay, you must install the enclosed diode—with the cathode (striped end) toward the positive side—for DC powered locks **OR** install the varistor (MOV, ) for AC powered locks and for electromagnetic locks **unless** your lock has a diode/MOV built in (all SECO-LARM electromagnetic locks have built-in protection). Do not install both diode and MOV. Failure to use these as directed will void the warranty.

†Use the blue wire (N.O. terminal) for fail-secure applications and the yellow wire (N.C. terminal) for fail-safe applications. Use electrical tape to insulate the end of any unused wire.

See *Installation Manual and Administrator Guide* online for details.

SL Access Quick Setup:

Understanding the SL Access Home Screen

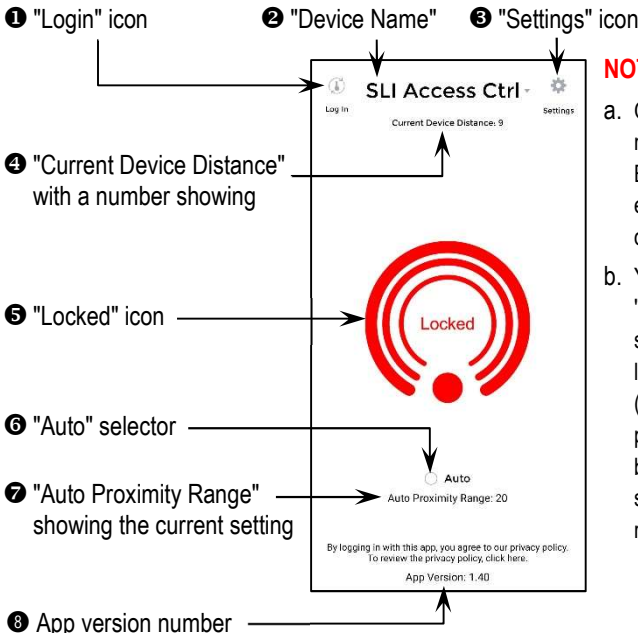

NOTES:

- On opening the app, you may get a message asking you to enable Bluetooth. Bluetooth must be enabled to use the app and the device must be in range.
- You may see the word "Searching..." at the top of the screen (see below). Bluetooth has a limited range of about 60 feet (20m), but will be much less in practice. Move closer to the device, but if "Searching..." continues to show you may need to exit and reopen the app.



Log In to the Device

- From a position near the device, click "Login" at the top left of the home screen.
- Type "ADMIN" (case sensitive) in the ID section.
- Type the factory default ADMIN passcode "12345" as the passcode and click "Confirm."



NOTES:

- The administrator's ID is ADMIN and cannot be changed.
- The factory default passcode should be changed from the "Settings" page immediately for better security (see pg. 4)
- Users will use the same app, and will log in in the same manner. The home and login screens will look the same, however their functionality will be limited to unlocking the door, choosing "Auto," and adjusting their "Auto Proximity Range" for the app's "Auto" unlock feature.

SL Access Quick Setup (Continued):

Manage Device and Set Device Settings

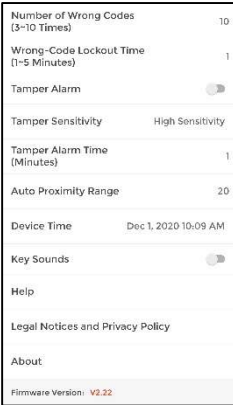
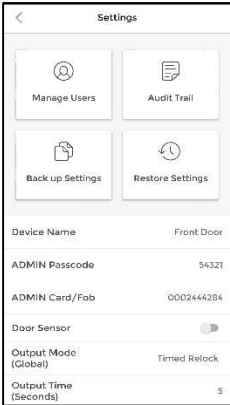

Below the function buttons are device settings:

- Device name – give a descriptive name
- ADMIN passcode – change immediately
- ADMIN proximity card
- Door sensor – required for the door-propped-open / door-forced-open alarm
- Output mode (global) – timed relock, remain unlocked, remain locked, or toggle
- Timed relock output time – 1~1,800 sec
- Number of wrong codes – Number that will trigger a temporary device lockout
- Wrong code lockout time – how long the device will remain locked out
- Tamper alarm – Vibration sensor
- Tamper vibration sensitivity – 3 levels
- Tamper alarm duration – 1~255 min
- Auto proximity range – for ADMIN app "Auto"
- Device time – automatically syncs with ADMIN phone date and time
- Key tone - keypad sounds can be disabled

Four function buttons allow you to:

- Open the user page to add or manage users
- View and download the audit trail
- Back up and restore device settings (also convenient for replicating to another device).

Manage Users

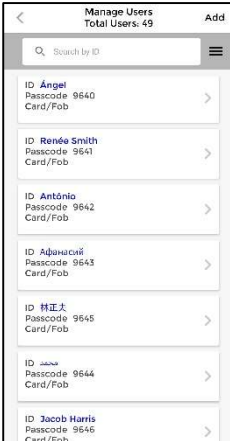

Add users by pressing the "Add" button top right. Current users will be listed in order of their addition

User Info

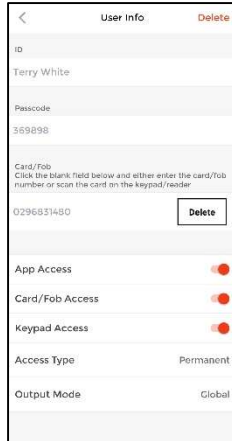

Edit users, add card/fob, set access, and override global output mode

Audit Trail



View last 1,000 events, save to phone, share, or email for archive

NOTICE: The SECO-LARM policy is one of continual development and improvement. For that reason, SECO-LARM reserves the right to change specifications without notice. SECO-LARM is also not responsible for misprints. All trademarks are the property of SECO-LARM U.S.A., Inc. or their respective owners. Copyright © 2024 SECO-LARM U.S.A., Inc. All rights reserved.

SECO-LARM® U.S.A., Inc.

16842 Millikan Avenue, Irvine, CA 92606
Phone: (949) 261-2999 | (800) 662-0800

Website: www.seco-larm.com
Email: sales@seco-larm.com

MQ_SKPR-Bxxx-xQ_240112.docx