

Surface-Mount Wave-to-Open Sensor with Manual Override Button



SD-9773-KNEVQ Manual Override

The ENFORCER Surface-Mount Wave-to-Open Sensor with Manual Override Button is a full-featured exit plate which uses IR technology to allow egress from a protected area or activate a device with the simple wave of a hand. Since no touch is required, this sensor is suitable for use in hospitals, clinics, labs, cleanrooms (to reduce the risk of contamination), schools, factories, or offices. A manual override allows for operation if the sensor is disabled.

Features

- Adjustable sensor range up to 6" (15cm)
- 1A relay, adjustable trigger duration 0.5-30 seconds or toggle
- LED illuminated sensor area for easy identification
- Selectable LED colors (turns from red to green or green to red when sensor is activated)
- Aluminum alloy and ABS plastic housing
- IP54 Weather-resistant for outdoor use



Specifications

Power	12-24 VDC	
Current drain (max.)	Standby (red)	20mA@12VDC / 26mA@24VDC
	Triggered (green)	26mA@12VDC / 32mA@24VDC
	Standby (green)	16mA@12VDC / 20mA@24VDC
	Triggered (red)	31mA@12VDC / 39mA@24VDC
Relay type	SPDT dry contact, 1A@24VDC	
Response time	10ms	
LEDs	Standby	Red†
	Triggered	Green†
Output time	0.5-30 s, toggle	
Range	1 ⁹ / ₁₆ "-6" (4-15 cm)	
IP rating	IP54‡	
Housing material	Aluminum alloy with ABS plastic	
Operating temperature	-4°~131° F (-20°~55° C)	
Dimensions	3 ¹ / ₈ "x 4 ¹ / ₂ "x1 ¹ / ₈ " (80x115x28mm)	
Weight	9.5-oz (270g)	

Sample Installation

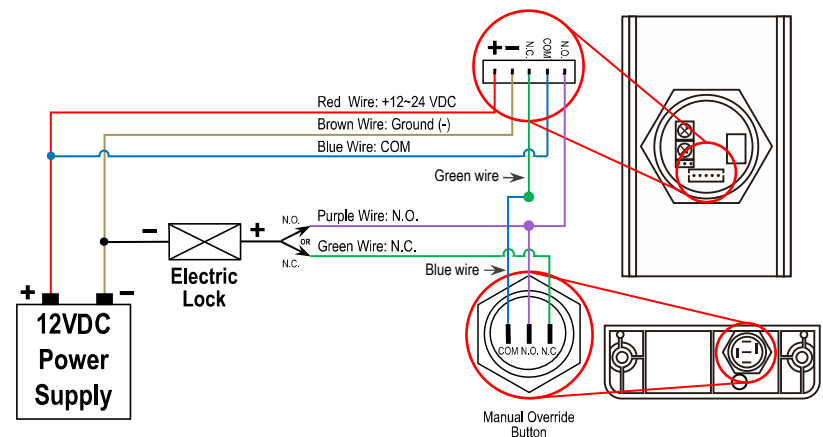

†Color function reversible

‡When properly installed

SECO-LARM® U.S.A., Inc.

16842 Millikan Avenue, Irvine, CA 92606

Phone: (949) 261-2999 | (800) 662-0800 Fax: (949) 261-7326

Website: www.seco-larm.com Email: sales@seco-larm.com









Copyright © 2022 SECO-LARM U.S.A., Inc. All rights reserved.

All trademarks are the property of SECO-LARM U.S.A., Inc. or their respective owners. The SECO-LARM policy is one of continual development. For that reason, SECO-LARM reserves the right to change prices and specifications without notice. SECO-LARM is not responsible for misprints.



SECO-LARM® ENFORCER® CRIMEBUSTER® CBA® SLI™

PI_SD-9773-KNEVQ_220830.docx



Ordering Information

Outdoor Wave-to-Open Sensors*						
Model	SD-9163-KSQ	SD-9263-KSQ	SD-9163-KS1Q	SD-9263-KS1Q	SD-9163-KS2Q	SD-9263-KS2Q
Language	English		Spanish		French	
Photo						

*Also available with European faceplate in English, Spanish, and French models

Outdoor Wave-to-Open Sensors with Override Button			
Model	SD-9163-KSVQ	SD-9263-KSVQ	SD-9763-KSVQ
Language	English†		
Photo			

†Spanish and French faceplates available by special order

Outdoor Wave-to-Open Sensors – Other Models		
Model	SD-9773-KNEVQ	SD-9963-KSGQ
Type	Surface-Mount	Post-Mount
Photo		

Other Models Also Available. For our full line of OEM/private label infrared sensors, contact SECO-LARM

SECO-LARM® U.S.A., Inc.

16842 Millikan Avenue, Irvine, CA 92606

Phone: (949) 261-2999 | (800) 662-0800 Fax: (949) 261-7326

Website: www.seco-larm.com Email: sales@seco-larm.com



Copyright © 2022 SECO-LARM U.S.A., Inc. All rights reserved. All trademarks are the property of SECO-LARM U.S.A., Inc. or their respective owners. The SECO-LARM policy is one of continual development. For that reason, SECO-LARM reserves the right to change prices and specifications without notice. SECO-LARM is not responsible for misprints.

SECO-LARM® ENFORCER® CRIMEBUSTER® CBA® SLI®