

## Curtain Barrier Sensors

### Installation Manual



E-9630-4S328DA shown



| Model          | # Beams | Length      | Range, Synchronous | Range, Asynchronous | Color  |
|----------------|---------|-------------|--------------------|---------------------|--------|
| E-9630-4S328DA | 4 Beams | 30" (76cm)  | Up to 328ft (100m) | 33~262ft (10~80m)   | Silver |
| E-9643-6S328DA | 6 Beams | 43" (108cm) | Up to 328ft (100m) | 33~262ft (10~80m)   | Silver |
| E-9655-8S328DA | 8 Beams | 55" (140cm) | Up to 328ft (100m) | 33~262ft (10~80m)   | Silver |

ENFORCER Curtain Barrier Sensors can be installed indoors or outdoors on windows, doorways, skylights, fence tops, and any place where space is limited.

- 4, 6, or 8 Separate photobeam sensors
- 2 Programmable trigger options – either breaking of any single beam or simultaneous breaking of any two adjacent beams (default)
- 2 Selectable frequencies to avoid interference from other nearby sensors
- Includes a 180° horizontal swivel housing for more flexible installation in various situations
- Supports synchronous or asynchronous operating modes
- 4 Adjustable sensitivity levels
- Rugged aluminum construction
- Tamper alarm output (N.C.) for use when housing is disturbed
- NO/NC relay output
- Buzzer indicator for easier alignment
- Mounting hardware included

**Table of Contents**

|   |   |   |    |
|---|---|---|----|
| <b>Parts List</b> .....                           | 2 | Side Views.....                           | 7  |
| <b>Sample Installations</b> .....                 | 2 | Top Views.....                            | 7  |
| <b>Specifications</b> .....                       | 3 | <b>Settings</b> .....                     | 8  |
| <b>Dimensions</b> .....                           | 3 | <b>Running the Cable</b> .....            | 9  |
| <b>Installation Considerations</b> .....          | 4 | <b>Connecting the Wires</b> .....         | 9  |
| Choosing a Location .....                         | 4 | Asynchronous Mode, Two Power Supplies.... | 9  |
| Mounting Considerations .....                     | 4 | Synchronous Mode, Single Power Supply ... | 10 |
| <b>PCB Layout and Jumper Settings</b> .....       | 5 | Synchronous Mode, Two Power Supplies....  | 10 |
| <b>Overview</b> .....                             | 6 | Completing the Wiring Connections .....   | 10 |
| <b>Setting Alarm Output and Detection Mode</b> .. | 6 | <b>Alignment and Testing</b> .....        | 11 |
| <b>Preliminary Mounting</b> .....                 | 6 | <b>Tamper Protection</b> .....            | 11 |
| <b>Typical Installations</b> .....                | 7 | <b>Troubleshooting</b> .....              | 12 |

**Parts List**

- |                |                                     |                         |
|----------------|-------------------------------------|-------------------------|
| 1x Transmitter | 4x Mounting screws (for wall mount) | 4x Plastic wall anchors |
| 1x Receiver    | 1x Manual                           |                         |

**Sample Installations**

Typical Door/Window Frame

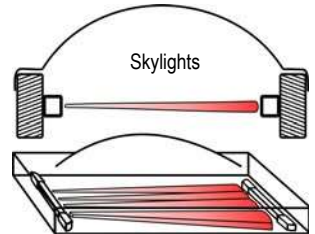
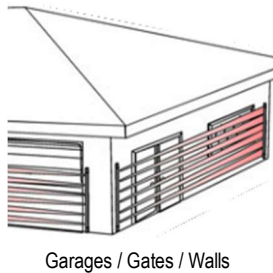
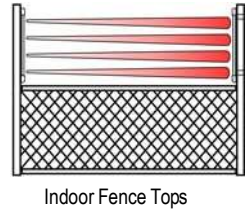
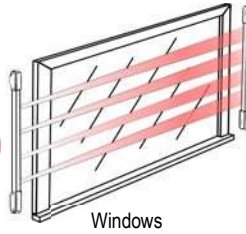
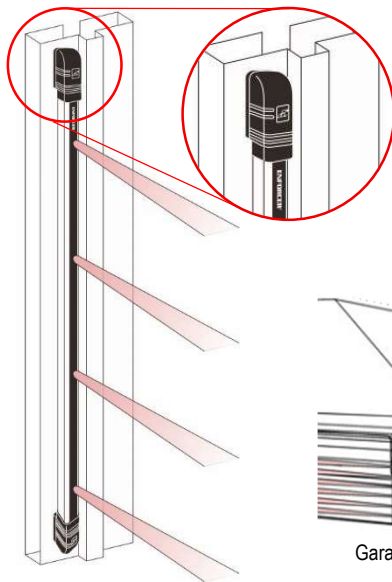

## Specifications

| Model                   | E-9630-4S328DA  | E-9643-6S328DA                            | E-9655-8S328DA                       |      |
|-------------------------|---|---|--------------------------------------|------|
| Type                    | Curtain barrier   |   |                                      |      |
| No. of beams            | 4   | 6   | 8                                    |      |
| No. of beam frequencies | 2   |   |                                      |      |
| Detection method        | Selectable, single beam or simultaneous breaking 2 adjacent beams (default) |   |                                      |      |
| Sensing range           | Synchronous   | Up to 328ft (100m)                        |                                      |      |
|                         | Asynchronous  | 33~262ft (10~80m)                         |                                      |      |
| Response time           | ≤40ms   |   |                                      |      |
| Operating voltage       | 9~30 VDC  |   |                                      |      |
| Current draw (max.)     | 12VDC TX  | 19mA                                      | 20mA                                 | 22mA |
|                         | 12VDC RX  | 24mA                                      | 26mA                                 | 24mA |
|                         | 24VDC TX  | 10mA                                      | 11mA                                 | 11mA |
|                         | 24VDC RX  | 11mA                                      | 12mA                                 | 12mA |
| Outputs                 | Trigger   | Selectable NO/NC (default, N.C.) 2A@30VDC |                                      |      |
|                         | Tamper  | 1A@125VAC/VDC                             |                                      |      |
| Tamper sensor           | N.C. switch,  |   |                                      |      |
| Triggered time          | ≥1s (or instant alarm, 0.1s)  |   |                                      |      |
| Light source            | IR LED  |   |                                      |      |
| Alignment indicator     | Buzzer  |   |                                      |      |
| Alignment angle         | Horizontal  | 180°                                      |                                      |      |
|                         | Vertical  | None                                      |                                      |      |
| IP Rating               | IP65 Weatherproof   |   |                                      |      |
| Operating temperature   | -22°~158° F (-30°~70° C)  |   |                                      |      |
| Material                | Aluminum body, polycarbonate lens cover and end caps                        |   |                                      |      |
| Dimensions              | 30"x17/8"x19/16"<br>(76x4.8x3.9 cm)   | 43"x17/8"x19/16"<br>(108x4.8x3.9 cm)      | 55"x17/8"x19/16"<br>(140x4.8x3.9 cm) |      |
| Weight (RX=TX)          | 2-lb 5-oz (1.05kg)  | 3-lb (1.4kg)                              | 3-lb 14-oz (1.75g)                   |      |

## Dimensions

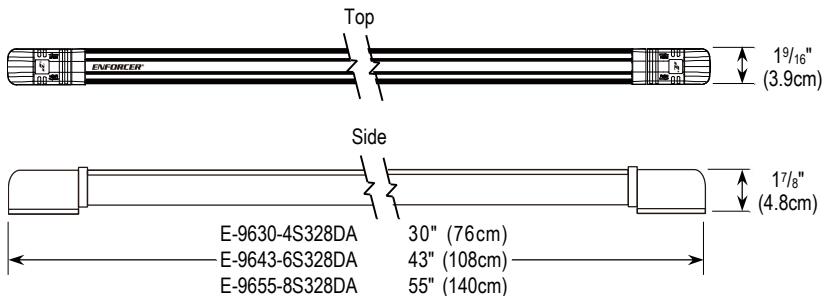

## Installation Considerations

**IMPORTANT:** Do not connect power until the sensors are completely installed and the installation has been double-checked.

If it becomes necessary to replace a sensor, always replace both the transmitter and receiver together.

### Choosing a Location

When used outdoors, install under an eave or shelter to reduce the chance of false alarms caused by rain or snow.

- Wind does not directly cause false alarms but could cause leaves or similar objects to fly or wave into the beams. Avoid mounting near trees, bushes, or other leafy vegetation (see Fig. 1).
- Do not mount where water running off a roof could break the beam (see Fig. 2). Provide some shelter over the beam path when mounting in such locations.
- Do not mount near reflective surfaces as this could scatter the beam and cause false triggers.
- Do not mount where the transmitter or receiver could be splashed by water or mud.
- Do not mount where the unit could be suddenly exposed to a bright light such as a floodlight or a passing automobile's bright headlight.
- Do not let sunlight or any direct beam of light shine directly on the sensor. If unavoidable, mount so the transmitter, not the receiver, faces the sun (see Fig. 3).
- Do not mount where animals or other objects could accidentally break the beams.

### Mounting Considerations

- If used indoors, the transmitter and receiver can be mounted at any angle as long as they are parallel to and directly facing each other, and as long as the wires exit the same ends of both units (see Fig. 4).
- If used outdoors, both should be mounted vertically with wires exiting from the bottom to prevent water from entering via the wire holes. If this is not possible, use silicone to completely seal and cover the area where the wires exit to prevent any possibility of water entering either unit (see Fig. 4).

Fig. 1



Fig. 2

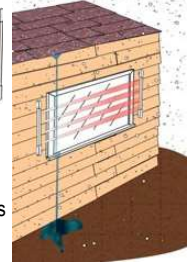

Fig. 3

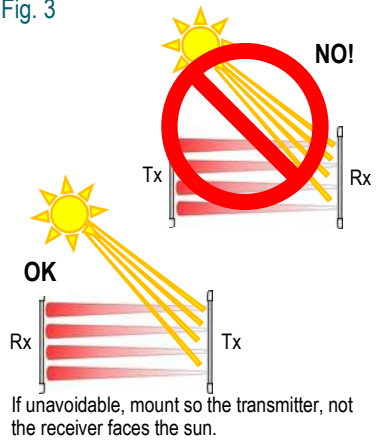
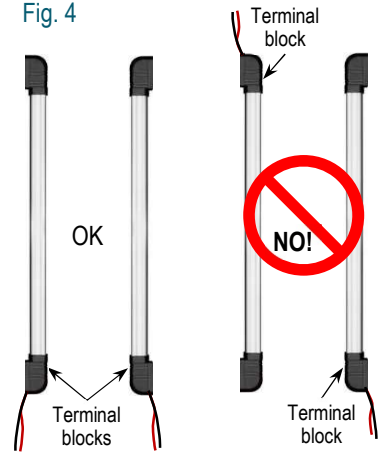
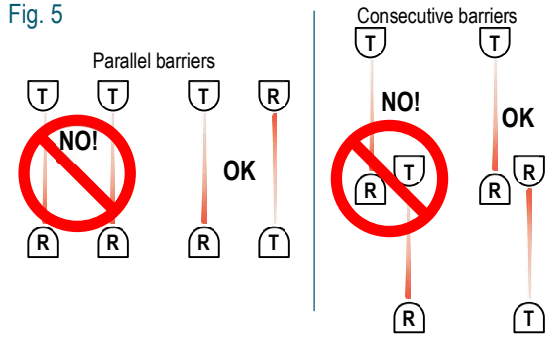

Fig. 4



## Installation Considerations (Continued)

- The transmitter and receiver must not be separated by more than 328ft (100m), synchronous or 262ft (80m), asynchronous mode.
- If multiple curtain sensors are set up to form longer or deeper barriers, mount so that one transmitter is not facing multiple receivers (see Fig. 5).
- Asynchronous mode may not be used when more than 3 pairs of transmitters and receivers are lined up in the same plane, either parallel or consecutive.



## PCB Layout and Jumper Settings

### Receiver (RX) (Fig. 6)

| Switch | Jumper | Result  |
|--------|--------|---|
| J1     | ON     | Frequency A* (default)  |
|        | OFF    | Frequency B*  |
| J5     | J2     | ON – Asynchronous mode† (default)                                       |
|        |        | OFF – Synchronous mode  |
| J3     | J3     | ON – Buzzer on (default)  |
|        |        | OFF – Buzzer off  |
| J4     | L      | ON – High TX power (default)  |
|        | M      | ON – Medium TX power  |
|        | S      | ON – Low TX power   |
|        | All    | OFF – Very low TX power   |
| J66    | NC     | NC + Center – N.C. output (default)                                     |
|        | Center |   |
|        | NO     | NO + Center – N.O. output   |
|        | FS1    | 2 Adjacent beams simultaneous, instant trigger (0.1 seconds to recover) |
| J22‡   | FS2    | 1 Beam, 2-second trigger time   |
|        | FS3    | 1 Beam, Instant trigger (0.1 seconds to recover)                        |

Fig. 6

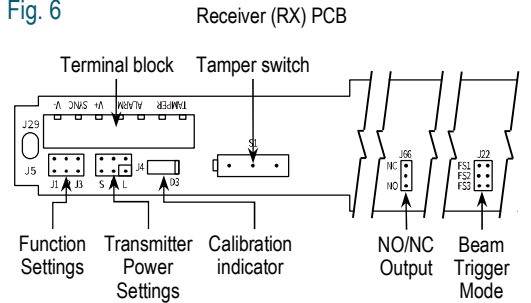

### Transmitter (TX) (Fig. 7)

| Switch | Jumper | Result                       |
|--------|--------|------------------------------|
| J10    | J1     | ON – Frequency A* (default)  |
|        |        | OFF – Frequency B*           |
| J4     | L      | ON – High TX power (default) |
|        | M      | ON – Medium TX power         |
|        | S      | ON – Low TX power            |
|        | All    | OFF – Very low TX power      |

Fig. 7

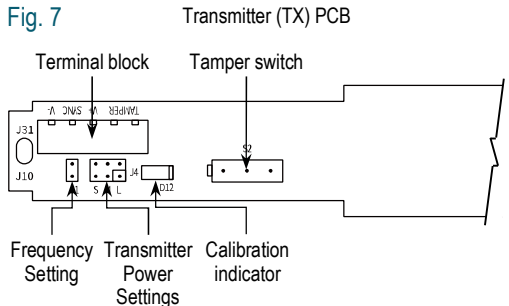

\*Frequency of transmitter and receiver must be the same.

†Asynchronous mode only available with 3 sets or less in the same line or plane.

‡By default, these jumpers are not set.

**Overview**

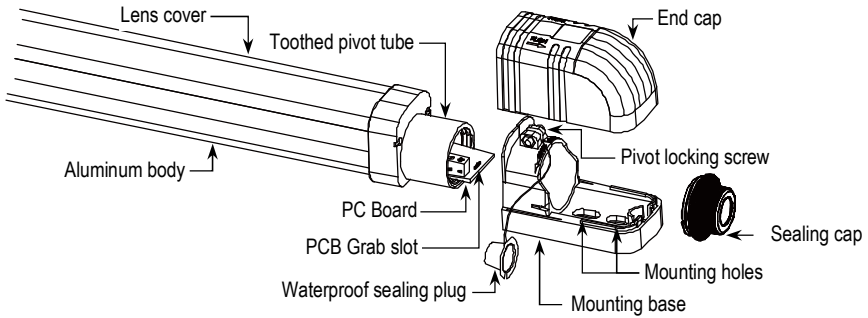

**Setting Alarm Output and Detection Mode**

If you need to change the *Alarm Output* (default, N.C.) or the *Detection Mode* (default, breaking of 2 adjacent beams and instant alarm), you must access the PCB from within the Receiver.

1. Note which end of the receiver (RX) has the hole for the wiring.
2. Gently pull that entire mounting end away from the main receiver body (see Fig. 8).
3. Gently slide the PCB out of the mounting end to access the *NO/NC Output* and *Beam Trigger Mode* jumpers.
4. Refer to the *PCB Layout and Jumper Settings* on pg. 5 to set the *NO/NC Output* (default, N.C.) or the *Beam Trigger Mode* (default, breaking of 2 adjacent beams, 2-second trigger time).
5. Carefully push the PCB back into the slots in the mounting base (see Fig. 9).

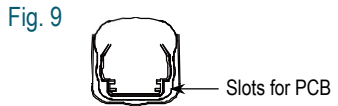
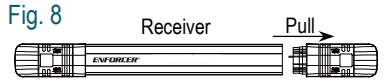

**Preliminary Mounting**

1. Once a suitable location has been found (carefully review *Installation Considerations*, pg. 4), remove the end caps from both ends of the transmitter and receiver by sliding them horizontally away from the mounting ends (see Fig. 10).

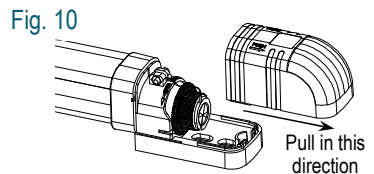

**NOTE:** Each end includes a swivel housing for more flexible installation in various situations without the need for additional brackets and to make alignment easier. With end covers removed, you may loosen the swivel lock screw to rotate the beams up to 90° in either direction (180° total, see Fig. 16, pg. 11 for more detailed instructions).

2. Locate the 2 sets of mounting holes (see *Overview*, pg. 6) for both the transmitter and receiver. Use these holes as a template and mark their location with a pencil.
3. Drill 1/4" (6mm) holes for the upper and lower mounting points and insert a plastic wall anchor. Pull the wiring for each through their wiring holes and then mount transmitter and receiver with the provided mounting screws.

**Typical Installations**

**Side Views**

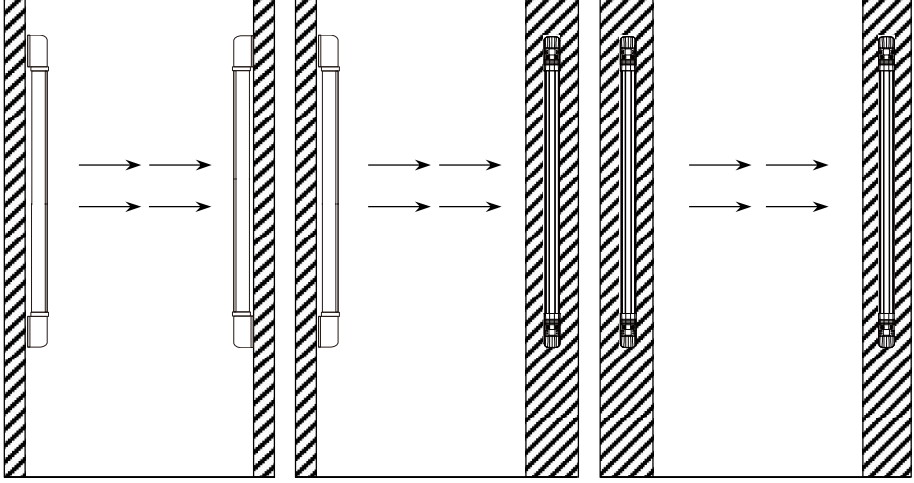

**Top Views**

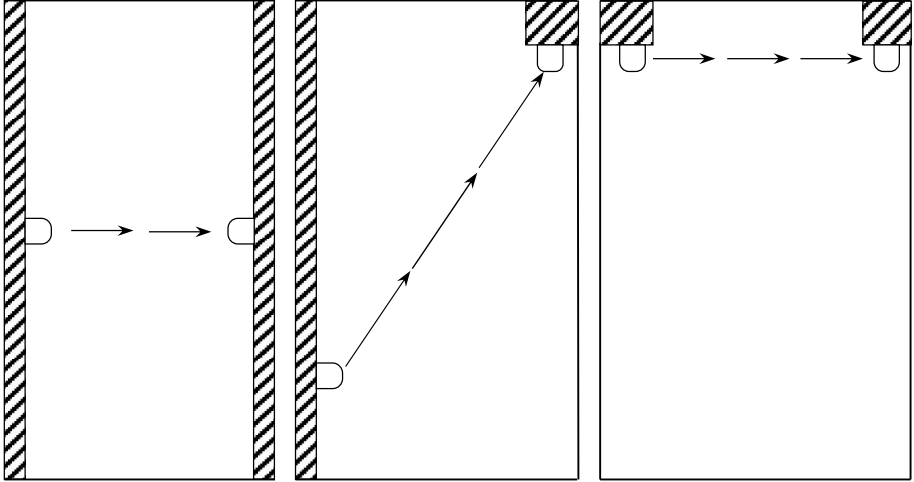

## Settings

To adjust the settings and connect the wiring, you will need to gain access to the PCB again, but this time from the outside and for both the transmitter and receiver. The following steps apply to both.

1. Remove the water-resistant sealing plug from the sealing cap (see Fig. 11).
2. Unscrew the sealing cap by turning it counterclockwise (see Fig. 12).
3. Insert a small screwdriver into the PCB grab slot and gently slide the PCB out slightly to connect the wires and set the jumpers for other settings (see Fig. 13).
4. Set jumpers using chart and diagram under *PCB Layout and Jumper Settings*, pg. 5 if you do not want the default settings for the:
  - a. Frequency (default, A) – Each receiver and transmitter pair must be the same frequency.
  - b. Asynchronous/synchronous mode (default, asynchronous) – Synchronous mode is only used for long distances and when more than 3 pairs of Curtain Sensors are used in the same line or plane.
  - c. Buzzer (default, ON) – The buzzer is used during installation for alignment and can be turned off afterwards or can be left on to provide an audible warning to intruders.
  - d. Transmitter power (default, high) – Both receiver and transmitter must be the same for each pair. Lower power is sufficient for shorter distances and avoids unnecessary energy use, reduces the risk of false triggers due to reflections or scattering, and can prevent interference when other sensors are used close together. Higher power is needed for longer distances or to penetrate dusty, foggy, or smoky environments. In some areas, lower power may be required due to safety standards.

Fig. 11

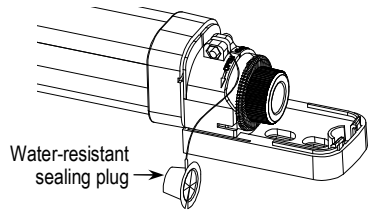

Fig. 12

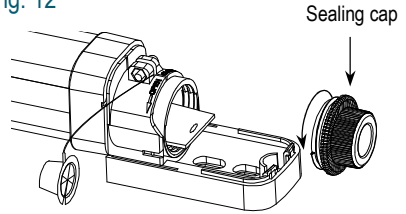
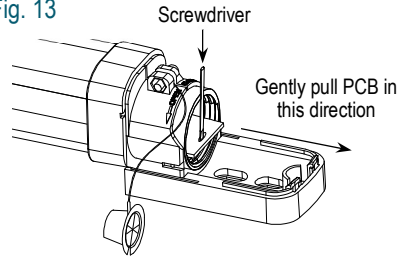

Fig. 13



## Running the Cable

Run a cable from an alarm control panel to the photobeam sensor. If burying the cable is required, make sure to use electrical conduit. A shielded cable is strongly suggested. See Table 1 for maximum cable length.

**Table 1: Cable length**

| Wire size | 12V           | 24V              |
|-----------|---------------|------------------|
| AWG22     | 1,050' (320m) | 9,186' (2,800m)  |
| AWG20     | 1,800' (550m) | 15,748' (4,800m) |
| AWG18     | 2,600' (800m) | 23,622' (7,200m) |
| AWG17     | 3,190' (980m) | 28871' (8200m)   |

## NOTES

- When two or more sets are connected, divide the value shown in Table 1 by the number of sets for the maximum cable length.
- The power line can be up to 3,300ft (1,000m) with AWG22 (0.33mm<sup>2</sup>) telephone wire.

## Connecting the Wires

1. Pass the wires to each unit through the sealing cap (see Fig. 14).
2. Connect the wires depending on your particular installation needs, consulting the wiring diagrams shown following and in accordance with the settings previously chosen (see *Settings*, pg. 7).

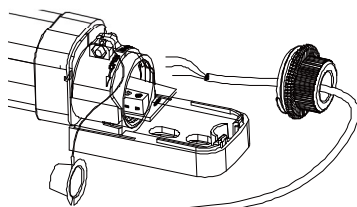

## Asynchronous Mode, Two Power Supplies

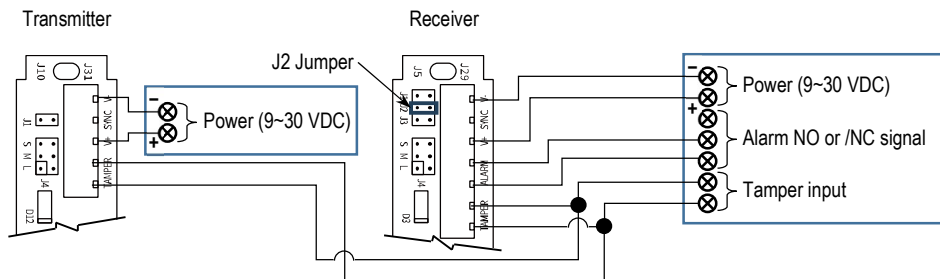

**NOTE:** Asynchronous mode may be used with up to three pairs of Curtain Barrier Sensors installed in the same line or parallel with each other. For more than three pairs in either of these configurations, synchronous mode must be used.



## Alignment and Testing

As noted earlier, each end includes a swivel housing for more flexible installation in various situations without the need for additional brackets and to make alignment easier.

1. With the end covers removed, loosen the swivel lock screw and rotate the beams up to 90° in either direction (see Fig. 16) as needed for your installation.
2. Connect the transmitter and receiver wiring and apply power.

Fig. 16

1. Loosen the swivel lock screw on each end.

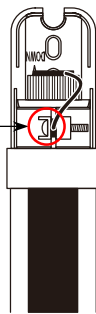

2. Twist the sensor tube up to 90° in either direction.

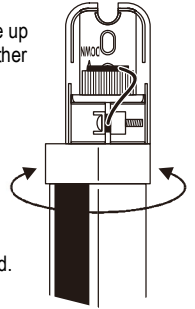

3. Retighten the swivel lock screw on each end.

3. Loosen the mounting screws if needed for vertical alignment and swivel the tubes as needed to adjust the transmitter and receiver horizontally (see *Typical Installations*, pg. 7).

4. When the two are properly aligned, the buzzer should not sound.
5. Turn one unit to the right and note the position where the buzzer begins to sound.
6. Turn the same to the left and note the position where the buzzer again begins to sound.
7. The position between the two extremes will give the best signal reception.
8. Repeat with the other unit.
9. Tighten the swivel lock screws, and the mounting screws as needed.
10. Test by blocking two adjacent beams.

**NOTE:** The buzzer jumper can be turned off at this time if desired.

11. Replace both end caps.

## Tamper Protection

The receiver and transmitter both have a tamper switch on each end (see Figs. 6 and 7, pg. 5) to protect against someone attempting to disarm the unit.

The tamper alarm output is triggered if the cover of the end cap with the tamper button is removed, if the transmitter or receiver is moved out of alignment, or if power is disconnected.

## Troubleshooting

LED on TX and RX are on but buzzer continues to sound when trying to align

- Ensure that both TX and RX are set to the same frequency
- Test the power and ground wire with a voltage meter to ensure power is connected and is of the correct voltage
- Check all wiring for loose connections
- Check whether the buzzer jumper J3 is on for both TX and RX
- Ensure that both units are within the rated detection range
- Ensure that there are no obstacles between the TX and RX

LED on RX flashes, TX LED is off, buzzer gives off short beeps

- Check the voltage supply to the TX
- Block each beam on the TX individually, ensuring that the buzzer sounds

Alarm sensitivity very slow

- Check whether 2 adjacent beams are already blocked
- Check for any reflective objects or surfaces that may reflect light to the RX. Repaint the surfaces or change the installation to reduce reflection
- Check for any bright light source pointing directly toward the RX
- Adjust the TX power to a lower level on both the TX and RX (J4 jumper)

Alarm is not triggered

- Block beams and ensure that the buzzer sounds
- Check wiring continuity to the alarm output relay
- Ensure that the wiring to the alarm panel has not been damaged
- Ensure that the TX and RX are not beyond the rated detection range
- Ensure that the power is correct and is the same on both RX and TX

False alarms

- Check the alarm panel programming
- Check to see if there may be interference from other sensors and adjust installation if needed
- Check leafy vegetation near sensors and cut back if needed or program for two-beam use
- Check for possible rainwater running from roof into the beam and correct if needed
- Check for other interference outdoors and provide shelter as necessary

**IMPORTANT:** Users and installers of this product are responsible for ensuring that the installation and configuration of this product complies with all national, state, and local laws and codes. SECO-LARM will not be held responsible for the use of this product in violation of any current laws or codes.

**California Proposition 65 Warning:** These products may contain chemicals which are known to the State of California to cause cancer and birth defects or other reproductive harm. For more information, go to [www.P65Warnings.ca.gov](http://www.P65Warnings.ca.gov).

**WARRANTY:** This SECO-LARM product is warranted against defects in material and workmanship while used in normal service for one (1) year from the date of sale to the original customer. SECO-LARM's obligation is limited to the repair or replacement of any defective part if the unit is returned, transportation prepaid, to SECO-LARM. This Warranty is void if damage is caused by or attributed to acts of God, physical or electrical misuse or abuse, neglect, repair or alteration, improper or abnormal usage, or faulty installation, or if for any other reason SECO-LARM determines that such equipment is not operating properly as a result of causes other than defects in material and workmanship. The sole obligation of SECO-LARM and the purchaser's exclusive remedy, shall be limited to the replacement or repair only, at SECO-LARM's option. In no event shall SECO-LARM be liable for any special, collateral, incidental, or consequential personal or property damage of any kind to the purchaser or anyone else.

**NOTICE:** The SECO-LARM policy is one of continual development and improvement. For that reason, SECO-LARM reserves the right to change specifications without notice. SECO-LARM is also not responsible for misprints. All trademarks are the property of SECO-LARM U.S.A., Inc. or their respective owners. Copyright © 2025 SECO-LARM U.S.A., Inc. All rights reserved.

**SECO-LARM® U.S.A., Inc.**

16842 Millikan Avenue, Irvine, CA 92606  
Phone: (949) 261-2999 | (800) 662-0800

Website: [www.seco-larm.com](http://www.seco-larm.com)  
Email: [sales@seco-larm.com](mailto:sales@seco-larm.com)

 PICAN5

ML\_E-96xx-xS328DA\_250829.docx